

JAGUAR XF SALOON AND XF SPORTBRAKE







BY APPOINTMENT TO
HM THE QUEEN
MANUFACTURERS OF
MOTOR VEHICLES
JAGUAR LAND ROVER LIMITED
COVENTRY



BY APPOINTMENT TO
HRH THE DUKE OF EDINBURGH
MANUFACTURERS OF
MOTOR VEHICLES
JAGUAR LAND ROVER LIMITED
COVENTRY



BY APPOINTMENT TO
HRH THE PRINCE OF WALES
MANUFACTURERS OF
MOTOR VEHICLES
JAGUAR LAND ROVER LIMITED
COVENTRY



JAGUAR

THE ART OF PERFORMANCE

Every day we push performance to its limit. Our performance. Our cars' performance.
We innovate, we engineer, we design. We master rules and then break them.
Only to push further. Past the limits of convention. This is when performance becomes art.
Jaguar. The Art of Performance.





CONTENTS

INTRODUCTION

The Concept of XF	07
XF - The Facts	08

DESIGN

Exterior Principles	10
Exterior Aerodynamics	12
Interior	15
Interior Space	17
Space and Versatility	19

PERFORMANCE

Engines Overview	22
Advanced Aerodynamics	26
Lightweight Aluminium Architecture	29
Chassis and Suspension	30

DRIVING TECHNOLOGY

Advanced Driving Dynamics	32
Added Driver Confidence	34
Advanced Drivetrain Technology	37
Torque Vectoring	39
Stability and Control	41

TECHNOLOGY

Infotainment	43
Connectivity	44
Audio	48

SAFETY AND EFFICIENCY

Driver Assistance	50
-------------------	----

PERSONALISATION

XF - Your Choice	52
Choose your Engine	54
New XF Chequered Flag	58
Choose your Model	60
Choose your Options	62
Choose your Colour	70
Choose your Wheels	72
Choose your Interior	74
Choose your Jaguar Gear - Accessories	92

SPECIAL VEHICLE OPERATIONS 100

THE WORLD OF JAGUAR 102

AT YOUR SERVICE 107

VEHICLES SHOWN: XF SPORTBRAKE S IN YULONG WHITE AND XF SALOON R-SPORT IN EIGER GREY WITH OPTIONAL FEATURES FITTED (MARKET DEPENDENT)
VEHICLES SHOWN ARE FROM THE JAGUAR GLOBAL RANGE. SPECIFICATIONS, OPTIONS AND AVAILABILITY WILL VARY BETWEEN MARKETS AND SHOULD BE VERIFIED WITH YOUR LOCAL JAGUAR RETAILER





INTRODUCTION

THE CONCEPT OF XF

XF possesses a combination of style and substance, enhanced by state-of-the-art technologies that help keep you safe, connected and entertained. Blending utterly seductive design with dynamics and refinement has resulted in the creation of the most premium and exciting business car of its generation. Whilst XF Sportbrake complements XF Saloon's distinctive lines and dynamism with even greater space and versatility.

Accentuating XF's award-winning design, Chequered Flag sharpens all the characteristics that lend themselves to Jaguar's rich racing heritage. From the best-selling powertrain selection to its sport-refined detailing, you'll feel the thrill of the finish line. But really, when you put your foot down, that's just the beginning.

VEHICLES SHOWN: XF SPORTBRAKE S IN YULONG WHITE AND XF SALOON R-SPORT IN EIGER GREY WITH OPTIONAL FEATURES FITTED (MARKET DEPENDENT)



XF - THE FACTS

An outstanding combination of advanced engineering, the latest technology and contemporary design sets XF apart.

EFFICIENCY AND PERFORMANCE

Find your perfect balance of economy and power in the XF Saloon and XF Sportbrake engine range. These are a new breed of diesel and petrol engines, designed for smooth, effortless performance day after day. Their all-aluminium construction goes a long way to reducing fuel consumption, and features such as Stop/Start technology improve your XF's efficiency - especially when driving in urban areas.

REAR AIR SUSPENSION

Even when fully loaded, XF Sportbrake's comfort and precise handling is maintained by self-levelling rear air suspension. This system automatically inflates air springs to counteract the weight of heavy loads, this helps ensure a level chassis and ride height.

DYNAMIC DESIGN

With a sleek, low swooping roofline and optional 1.6m² panoramic glass roof, XF Sportbrake makes no compromise between assertive style and versatility. Perfectly executed to carry more, its proportions have been shaped to achieve aerodynamic excellence.



ADDED INTELLIGENCE

Innovative technologies make every drive easier and safer. XF offers Adaptive LED headlights, Traffic Sign Recognition and Adaptive Speed Limiter, Lane Keep Assist and Driver Condition Monitor, Autonomous Emergency Braking, Adaptive Cruise Control with Queue Assist, Park Assist and Blind Spot Assist. With Powered gesture tailgate/boot lid you can access the boot when your hands are full. Simply present your foot under either rear corner and the boot opens or closes.

¹40:20:40 split fold rear seats are standard on XF Sportbrake.

²Feature only available with Navigation Pro, CD/DVD Player and Meridian™ Sound System.

³XF Saloon only. Drag coefficient for XF Sportbrake is Cd 0.29.

Some features described here are optional and market dependent. Features and their availability may differ by vehicle specification. For more details on feature availability refer to pages 62-69 or configure your vehicle at jaguar.com.

Please refer to the accompanying Technical Specification for full details on Drive line, Engine Performance and Fuel Economy.

VEHICLES SHOWN: XF SPORTBRAKE S IN YULONG WHITE AND XF SALOON R-SPORT IN EIGER GREY WITH OPTIONAL FEATURES FITTED (MARKET DEPENDENT)

CRAFTSMANSHIP AND SPACE

Contemporary craftsmanship and a luxurious, practical interior with the space to stretch out and enjoy every journey. Your front and rear passengers will appreciate leg, knee and headroom that are among the best in class. You can choose the optional 40:20:40 rear seating¹ configuration for increased volume and versatility.

CONNECTIVITY

Every drive in XF is enhanced by InControl technologies. InControl is a suite of products and services that connects you with your XF and links XF to the wider world. It ensures you are always in touch. With the option of Dual View², front passenger and driver can enjoy different media on the same Touchscreen.

LIGHTWEIGHT ALUMINIUM ARCHITECTURE

XF's Lightweight Aluminium Architecture creates an incredibly strong body that delivers precise and responsive sports handling with impressive fuel efficiency.

ADVANCED DRIVETRAIN TECHNOLOGY

XF offers Jaguar's unique All Wheel Drive with Intelligent Driveline Dynamics (IDD) and Adaptive Surface Response (AdSR) on both petrol and diesel models. This maximises the legendary Jaguar handling, agility and ride, and gives added confidence in all conditions.

ADVANCED AERODYNAMICS

XF is capable of achieving a drag coefficient of just Cd 0.26³. Even the underside of the car is aerodynamically designed to be as smooth as possible, while apertures in the front bumper optimise airflow through the wheel arches. XF cuts through the air, reducing wind noise for enhanced refinement and improved efficiency.





DESIGN EXTERIOR PRINCIPLES



DESIGN PURITY

ADAPTIVE LED HEADLIGHTS

"It's about paring it down to the bare essentials. Good designers have always said less is more."
Ian Callum, Jaguar Design Director.

XF demonstrates the Jaguar principles of design purity. Strong lines radiate dynamic character and enhance its capabilities – be it improving aerodynamics, visibility, stability or safety. XF is available with Adaptive LED headlights* featuring Jaguar signature 'J' blade Daytime Running Lights to give XF a striking on road presence. The quality of LED light is close to daylight, helping your eyes to distinguish objects more easily and reducing fatigue at night.

*Optional feature, Xenon or Halogen headlights are also available depending on the model chosen.

VEHICLE SHOWN RIGHT: XF SALOON R-SPORT IN EIGER GREY WITH OPTIONAL FEATURES FITTED (MARKET DEPENDENT)



776 XCN

EXTERIOR AERODYNAMICS



AERODYNAMIC DESIGN

F-TYPE INSPIRED DESIGN

XF's sweeping exterior design is naturally aerodynamic. Its advanced form enhances handling, dynamics and refinement. Airflow is carefully managed through and around the car. Intakes either side of the front grille draw air in, then channel it out from the wheel arches to reduce turbulence. As air flows along the car, pressure differences that can cause drag are minimised by the flush, aerodynamically optimised sides.



At the rear, XF's tail lights feature a distinctive, F-TYPE inspired roundel and intersecting horizontal detail. The LED brake lights are not only brighter than halogen bulbs, they use less energy – contributing to XF's overall drive for greater efficiency. LEDs also illuminate faster – so following drivers can react more quickly to XF's braking. Within the tail lights is a pinstripe graphic – one of XF's many exquisite finishing touches.

VEHICLES SHOWN: XF SPORTBRAKE S IN YULONG WHITE AND XF SALOON R-SPORT IN EIGER GREY WITH OPTIONAL FEATURES FITTED (MARKET DEPENDENT)





JAGUAR

140 180 220 260 300
0
60 80 100 120 140 160 180 200 220 240 260 280 300

3 4 5
P
1 2

HOME

2:56 PM

Navigation

Media

Phone

Arlington Avenue
Leamington Spa
P 65km 4:55pm

Bluetooth audio
Young Before Your Time
Corvidae

My iPhone

SYNC

Bluetooth

Navigation

AUTO

16.5

MAX

MAX A/C

A/C

P R N D S



INTERIOR



**DRAMATIC
START-UP SEQUENCE**

**CONTEMPORARY
CRAFTSMANSHIP**

Open XF's door and the Start button entices you inside. Pulsing with a heartbeat it creates an emotional connection between driver and machine. Its 72 per minute double beat is the same as a jaguar cat at rest. XF is poised, ready for action. Now push the Start button. The car awakens and its mood lighting illuminates. With perfect choreography, air vents rotate open, the JaguarDrive Selector rises smoothly, and the engine growls - all inspiring you to anticipate the drive ahead.

XF's interior offers outstanding comfort, a sense of wellbeing and a wealth of choice. The number of switches and buttons is kept to a minimum to keep the look clean and tidy, as well as making them easy to use. Whichever XF interior combination you choose, materials used are always of the highest quality. Leather and finishes are selected with the greatest care to ensure that, inside XF, everything is luxurious to the touch. Whether you prefer aluminium, carbon fibre, or wood veneer finishes to complement the beautiful selection of leathers, your XF will always look and feel just right.

To enhance the cabin's sense of wellbeing, XF Sportbrake offers a Cabin Air ionisation system that improves air quality. This optional nanoe™ technology enhances the well-being of both driver and passengers alike. It improves the air quality within the vehicle cabin by removing allergens, viruses, airborne bacteria and associated odours. It does so by ionising particles in the air, making them attract to and neutralise the air contaminants. It can be switched on or off.

INTERIOR SHOWN: XF SALOON S FEATURING LIGHT OYSTER/EBONY SEATS WITH EBONY UPPER FACIA WITH CONTRAST STITCH, EBONY CARPET AND EBONY HEADLINING WITH OPTIONAL FEATURES FITTED (MARKET DEPENDENT)





1. Headroom 970mm (995mm* on XF Sportbrake) 2. Knee room 89mm

INTERIOR SPACE



GENEROUS REAR SPACE

IMPRESSIVE VERSATILITY

In both XF Saloon and XF Sportbrake, the rear of the cabin is a destination of luxury, choice and space. The generous rear knee room is among the best in class, while the ample rear legroom and rear headroom give you room to relax. It all adds up to greater comfort and wellbeing for passengers.

Interior lighting also enhances XF's atmosphere. Opt for Configurable Ambient Interior Lighting and you'll have a choice of ten interior colours. The choice continues with optional Four-zone Climate Control, giving individual passengers the opportunity to set their own temperature and airflow.

At 540 litres, the loadspace of XF Saloon offers plenty of carrying capacity. For even greater versatility, choose the optional 40:20:40 rear seating configuration – it increases loadspace to an impressive 885 litres. This outstanding practicality is taken to the next level in XF Sportbrake.

*991mm with optional fixed panoramic roof on XF Sportbrake.

INTERIOR SHOWN: XF SALOON S FEATURING LIGHT OYSTER/EBONY SEATS WITH EBONY UPPER FACIA WITH CONTRAST STITCH, EBONY CARPET AND EBONY HEADLINING WITH OPTIONAL FEATURES FITTED (MARKET DEPENDENT)



SPACE AND VERSATILITY



SUBSTANTIAL LOADSPACE

ACTIVITY KEY

XF Sportbrake's versatile interior is designed to meet the demands of your lifestyle. Its loadspace provides up to 565 litres of space with the rear seats in place. Fold the rear seats down, and you'll create a space that is two metres in length and over a metre in width at its narrowest point, featuring up to 1,700 litres of luggage capacity plus discreet underfloor stowage.

To make everything that bit easier, XF Sportbrake offers a powered tailgate as standard, and a Powered gesture tailgate* and Activity Key as options. Activity Key is a robust and fully waterproof wristband that allows you to enjoy a range of activities - from skydiving to swimming - while giving you immediate access to the car at all times. The conventional key fob can remain within the car as it is deactivated for security purposes.

*Feature only available with Keyless Entry.

INTERIOR SHOWN: XF SPORTBRAKE S FEATURING BROGUE SEATS WITH CONTRAST STITCH, EBONY CARPET AND EBONY HEADLINING WITH OPTIONAL FEATURES FITTED (MARKET DEPENDENT)







40:20:40 SPLIT FOLD SEATS

FIXED PANORAMIC ROOF

XF Sportbrake's rear seats fold completely flat or can be divided with a 40:20:40 split, using a thoughtfully placed remote release that's accessible from the tailgate area. Easy-to-use loadspace rails help further increase the adaptability of loadspace stowage, and a divider net prevents objects from falling onto the rear seats.

Introducing even more natural light and airiness to the interior, XF Sportbrake's optional 1.6m² fixed panoramic roof has the largest single piece of roof glass in its class. There's also the option of a gesture roof blind that can be opened and closed with a simple swipe of your hand without you ever having to take your eyes off the road.

PERFORMANCE ENGINES OVERVIEW



INGENIUM ENGINES

STOP/START TECHNOLOGY*

Ingenium technology underpins three of the diesel engines in the XF range. These low friction, all-aluminium engines have stiff cylinder blocks and twin balancer shafts to ensure inherently low levels of vibration, for smooth day-to-day performance. All engines are equipped with Stop/Start technology* and smart regenerative charging - harvesting kinetic energy from braking to charge the battery - for maximum economy, especially during urban driving. XF's diesel engines are available with either a 6-speed Manual Transmission that provides slick, short changes or an 8-speed Automatic Transmission that is highly responsive, smooth and efficient.



AdBlue®

INGENIUM DIESEL ENGINES UP TO

0-100km/h in 6.9 seconds**

The **Ingenium 2.0 litre 4-cylinder 163PS Turbocharged Diesel** is refined and efficient. Low-flow direct injectors precisely control the amount of fuel that enters the combustion chamber for maximum efficiency. Intelligent, electronically controlled, adaptive engine cooling only engages when required - minimising fuel consumption and CO₂ emissions. This doesn't limit driving pleasure, the engine's strong torque gives good performance from low down in the rev range for brisk acceleration.

The **Ingenium 2.0 litre 4-cylinder 180PS Turbocharged Diesel** offers performance and economy. For an engine of this size it offers high levels of torque, but not at the expense of efficiency - a balance achieved thanks to its variable geometry turbocharger. Adapting to the changing flow of exhaust gases, it maximises low speed torque for broad power and responsiveness that is uniform, progressive and avoids lag.

The **Ingenium 2.0 litre 4-cylinder 240PS Twin Turbocharged Diesel** delivers high power and torque. Its series sequential twin turbocharger uses high and low pressure spools to give continuous acceleration and maximise performance. A higher specific power output is created by building on Ingenium technology. Upgrades include a higher pressure common rail fuel system, increased from 1,800 to 2,200 bar, and an improved fuel injector flow rate.

*Market dependent.

**Engine performance and efficiency figures representative of XF Saloon only.

Please refer to the accompanying Technical Specification for full details on Drive line, Engine Performance and Fuel Economy.



AdBlue®

DIESEL ENGINE

0-100km/h in 6.4 seconds**

The **3.0 litre V6 300PS Twin Turbocharged Diesel** engine offers exceptional power, torque and drivability. It uses innovative twin-parallel sequential turbocharging - a concept pioneered by Jaguar Land Rover - for smooth, more immediate delivery of power at all engine speeds, as well as two-stage water cooling to conserve energy.

XF offers a choice of two petrol engines from our Ingenium range. With their lightweight, all-aluminium design, and widespread use of low-friction roller bearings, Ingenium petrol engines are built for smooth, highly efficient performance. To guarantee a responsive drive and effortless acceleration, every XF petrol engine makes use of a rapid-shifting, 8-speed Automatic Transmission. All engines are equipped with Stop/Start technology* and smart regenerative charging – harvesting kinetic energy from braking to charge the battery – for maximum economy, especially during urban driving.



INGENIUM PETROL ENGINES UP TO

0-100km/h in 5.9 seconds**

The **Ingenium 2.0 litre 4-cylinder 250PS Turbocharged Petrol** engine delivers outstanding usable power and torque. For excellent acceleration and effortless overtaking, maximum torque is available between 1,300-4,500rpm. This engine's twin scroll turbocharger is fed by an integrated exhaust manifold that synchronises exhaust pulses from two separate pairs of cylinders – significantly reducing turbo lag and improving engine response.

The **Ingenium 2.0 litre 4-cylinder 300PS Turbocharged Petrol** engine's impressive power is balanced with strong fuel economy. For almost instant boost and high efficiency, its low inertia twin-scroll turbocharger features low-friction ball bearings and a high flow compressor wheel. Underpinned by the turbocharger's increased aerodynamic efficiency, the engine delivers rapid acceleration and maximum torque of 400Nm between 1,500-4,500rpm.

*Market dependent.

**Engine performance and efficiency figures representative of XF Saloon only.

Please refer to the accompanying Technical Specification for full details on Drive line, Engine Performance and Fuel Economy.

VEHICLE SHOWN: XF SPORTBRAKE R-SPORT IN EIGER GREY WITH OPTIONAL FEATURES FITTED (MARKET DEPENDENT)



ADVANCED AERODYNAMICS



LOW DRAG

| CD 0.26*

XF's form has been rigorously optimised for aerodynamic efficiency and stability at motorway speeds. With a drag coefficient as low as Cd 0.26*, XF cuts through the air - reducing fuel consumption and lowering emissions. Every element exploits the exterior's maximum aerodynamic potential while preserving XF's stunning proportions. Vertical apertures in the front bumper outer edges channel air through vents in the wheel arches and out over the front wheels. The airflow then passes along XF's sides where the doors have a flatter cross sectional profile to minimise air pressure differences and contribute further to reduced drag. Even the extensive under body protection is designed to make XF as efficient, economical and refined as possible.

*XF Saloon only. Drag coefficient for XF Sportbrake is Cd 0.29.

VEHICLE SHOWN: XF SALOON PORTFOLIO IN SANTORINI BLACK WITH OPTIONAL FEATURES FITTED (MARKET DEPENDENT)



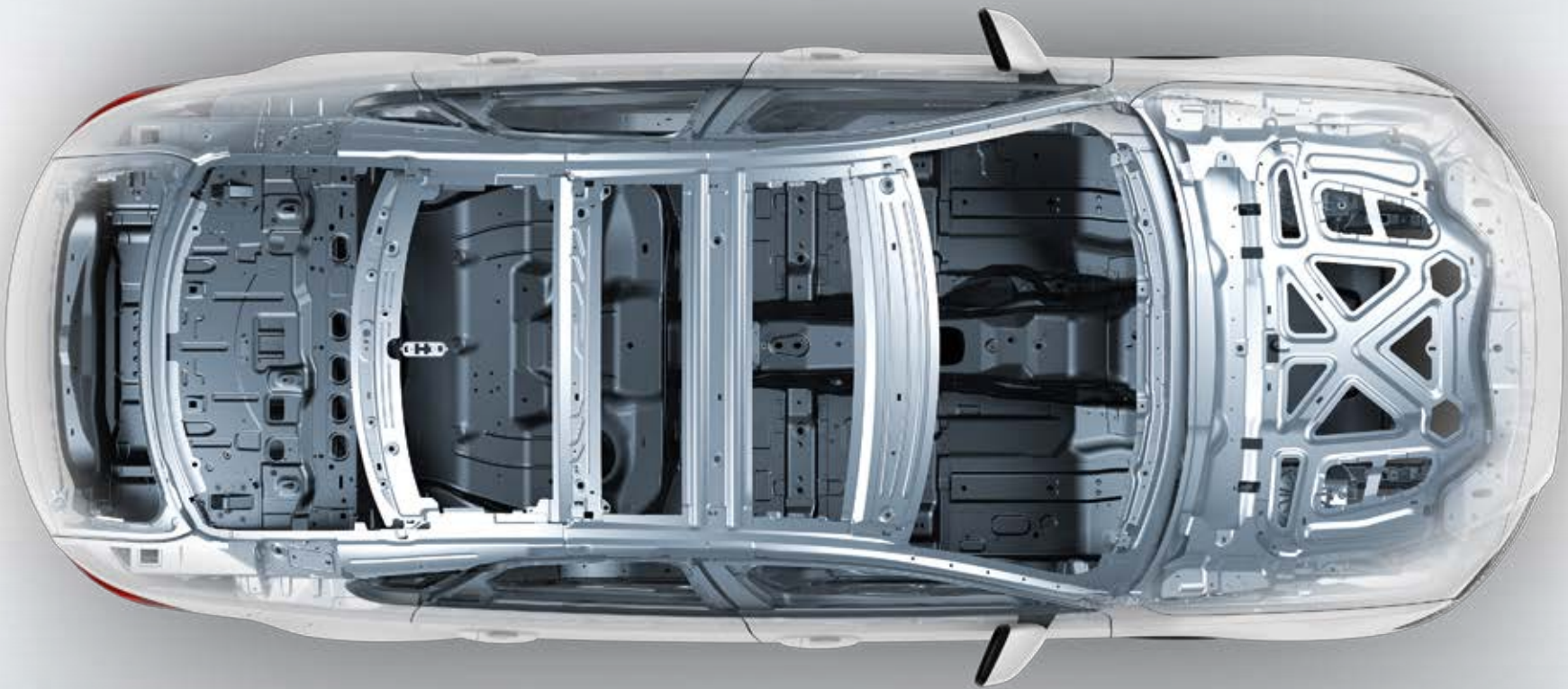

LIGHTWEIGHT ALUMINIUM ARCHITECTURE

 **STRONG** | **RIGID** | **75% ALUMINIUM**

Jaguar has been at the forefront of aluminium car construction for more than a decade. The latest innovation is our high-strength Lightweight Aluminium Architecture, which is not only incredibly strong and reduces weight, it is also extremely stiff - underpinning XF's precise, agile handling. Aluminium has also been used to form the body sides, bonnet and front wings. These panels are bonded together with a super-strong adhesive, then punched with zinc-coated, boron steel rivets that compress the adhesive to form an airtight bond and a phenomenally strong, rigid structure. This cutting-edge process, coupled with the Lightweight Aluminium Architecture, makes XF among the lightest cars in its class. This weight saving goes a long way to reducing fuel consumption.

Please refer to the accompanying Technical Specification for full details on Drive line, Engine Performance and Fuel Economy.

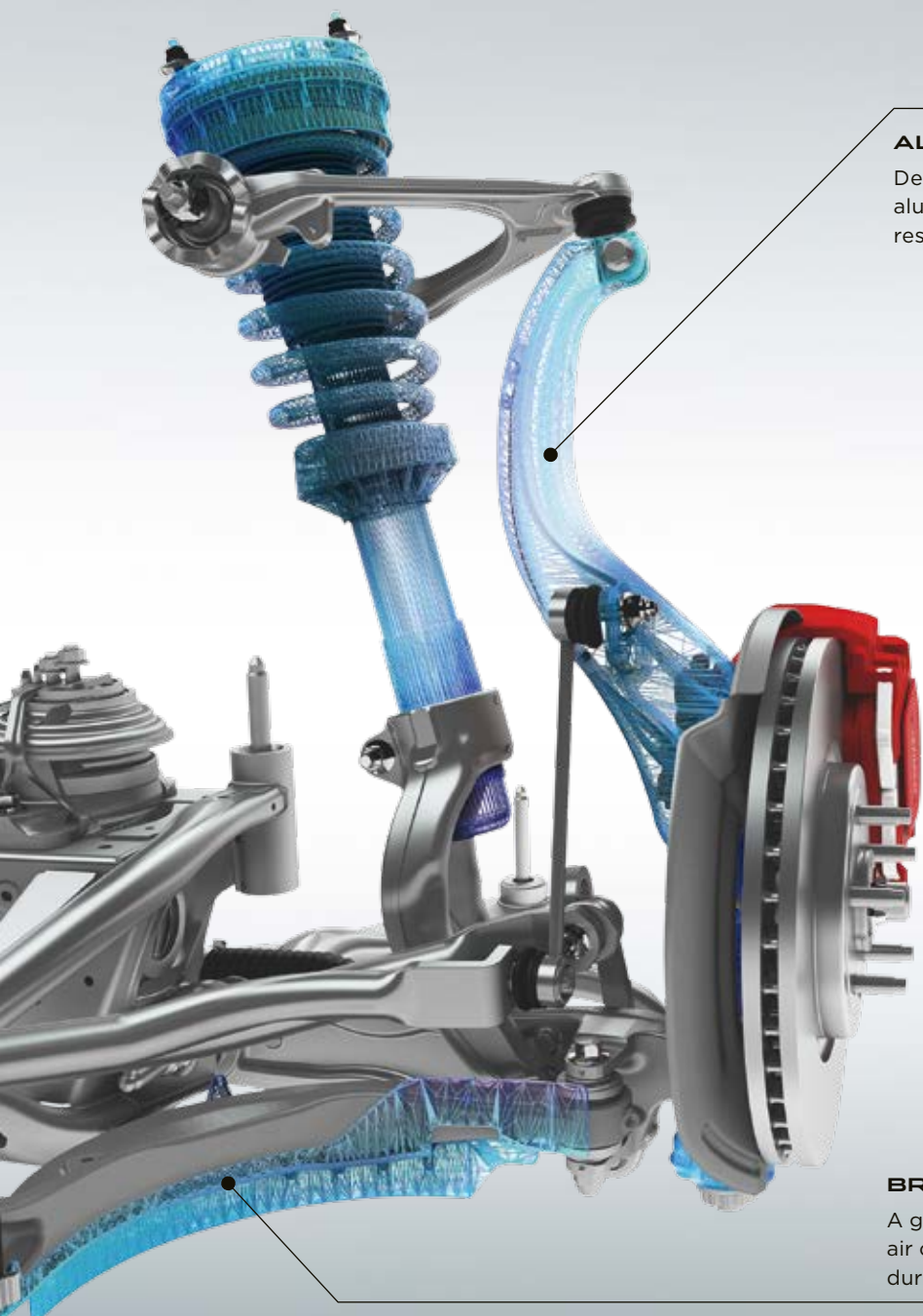

ALUMINIUM FRONT KNUCKLE

Designed to optimise stiffness and strength, the lightweight aluminium front knuckle helps improve XF's agility, responsiveness and refinement for sports car-like control.

CHASSIS AND SUSPENSION



UNIQUE SUSPENSION
TECHNOLOGY

COMFORTABLE
AND DYNAMIC

XF responds with agility and performs with dynamism while always maintaining ride comfort - it's a unique balance that makes it a Jaguar. The ideal foundation for these driving dynamics is XF's light, yet exceptionally strong and stiff, Lightweight Aluminium Architecture with its near 50:50 weight distribution.

The sophisticated front and rear suspension systems complete a chassis that achieves a superb combination of sportiness and refinement. Advanced damper technologies - both passive or adaptive - improve ride quality still further and extend XF's breadth of dynamic capability. The suspension's control, agility and feedback give XF the spirit of a sports car.

BRAKE SCOOP

A glass-filled polypropylene brake scoop channels air onto the brakes for enhanced brake performance during enthusiastic driving.

INTEGRAL LINK REAR SUSPENSION

Integral Link suspension allows XF to realise a perfect combination of a refined, luxurious ride and sharp, responsive handling. The system, the benchmark for this class of car, separates and independently manages the lateral, longitudinal and vertical forces acting on the suspension for enhanced control and comfort. Many components are forged or hollow-cast in aluminium – the optimum production techniques for strong, lightweight suspension.

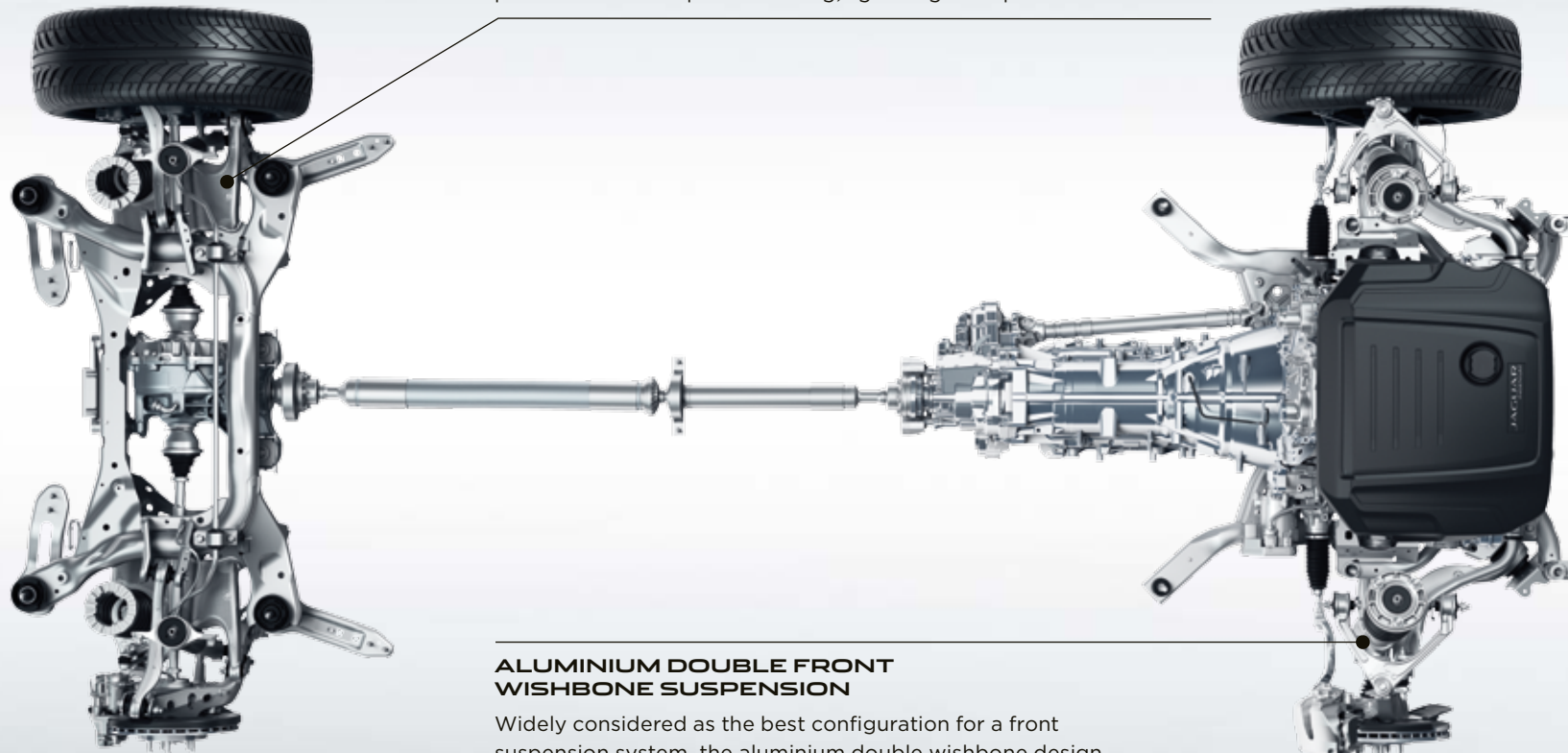

ALUMINIUM DOUBLE FRONT WISHBONE SUSPENSION

Widely considered as the best configuration for a front suspension system, the aluminium double wishbone design is modelled closely on F-TYPE's for precise handling and steering response.

DRIVING TECHNOLOGY

ADVANCED DRIVING DYNAMICS

> MAXIMISING AGILITY

Dynamic Mode revises the car's software to further enhance XF's sporting character. It sharpens the throttle response, increases steering weighting and performs gearshifts more quickly¹ and at higher engine speeds. It also brings visual drama to the driver as the instrument cluster takes on a red glow. Dynamic Mode enhances your connection with XF's inherent Jaguar performance.

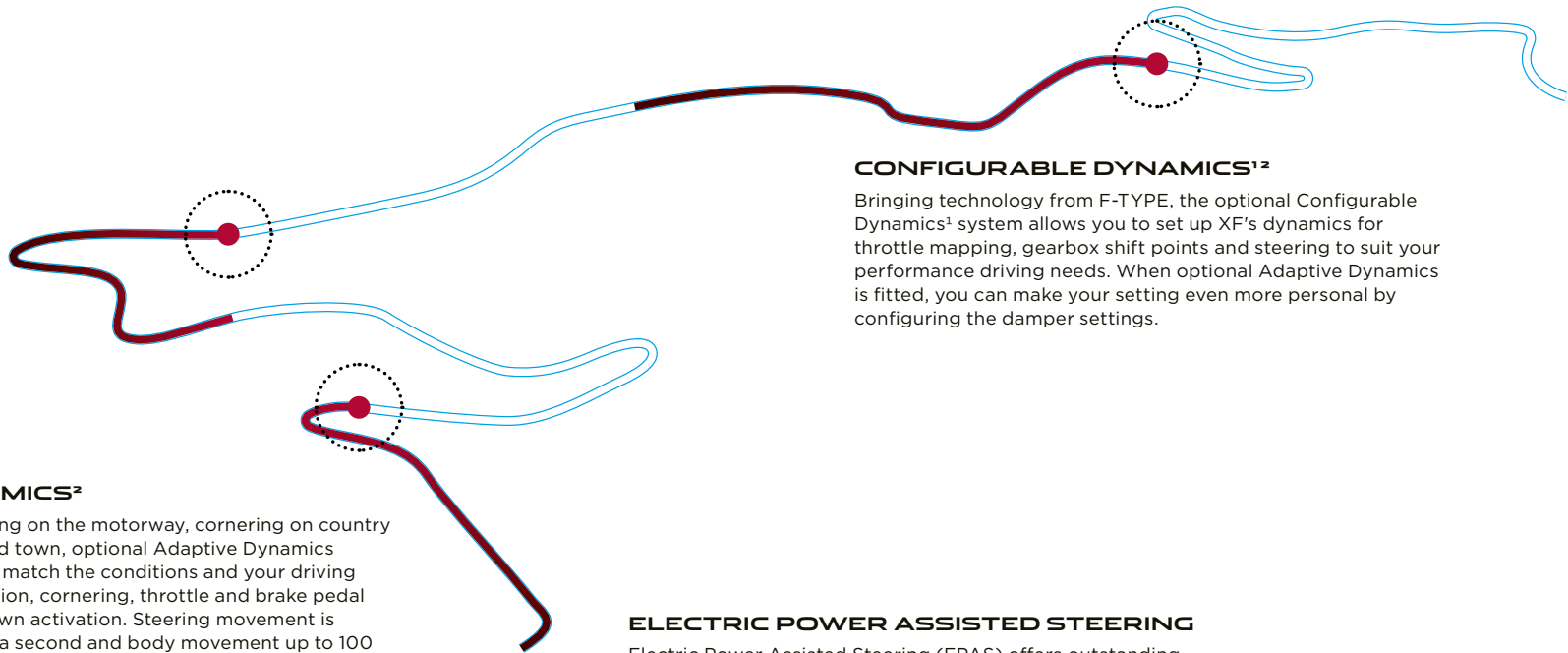

ADAPTIVE DYNAMICS³

Whether you're accelerating on the motorway, cornering on country roads or navigating around town, optional Adaptive Dynamics modifies XF's response to match the conditions and your driving style. It analyses acceleration, cornering, throttle and brake pedal activity, as well as kick-down activation. Steering movement is analysed up to 500 times a second and body movement up to 100 times a second. Using this information, electronically controlled adaptive dampers then constantly adjust to optimise the suspension settings and maintain XF's poise and comfort.

CONFIGURABLE DYNAMICS^{1,2}

Bringing technology from F-TYPE, the optional Configurable Dynamics¹ system allows you to set up XF's dynamics for throttle mapping, gearbox shift points and steering to suit your performance driving needs. When optional Adaptive Dynamics is fitted, you can make your setting even more personal by configuring the damper settings.

ELECTRIC POWER ASSISTED STEERING

Electric Power Assisted Steering (EPAS) offers outstanding feedback, control and it is active on demand - saving power for where you really need it, as well as saving fuel. EPAS' sophisticated computer management varies steering assistance as appropriate - increasing assistance for low speed manoeuvring and improving feel at higher speeds. It also enables advanced safety features such as Lane Keep Assist and Park Assist³.

¹Automatic transmission only.

²Standard on XF S, not available on 2.0 litre 4-cylinder 163PS Diesel engine.

³Optional feature.



ADDED DRIVER CONFIDENCE



ALL SURFACE PROGRESS CONTROL¹

ADAPTIVE SURFACE RESPONSE

Unique in this class of car, Jaguar's All Surface Progress Control (ASPC) technology is a low speed cruise control that helps XF to cope with low traction situations. ASPC allows the driver to concentrate on steering the vehicle. Once activated, you use the cruise control buttons to set a 'target' speed of between 3.5km/h and 30km/h. The system then works to achieve and maintain that speed while exerting optimum traction control.

ASPC is standard on all engines fitted with automatic transmissions and gives XF drivers added confidence over slippery, loose or icy surfaces, undulating terrain and even while descending a difficult incline. It helps make XF easy to drive in challenging conditions. ASPC also has a pull-away function allowing XF to progress from rest on low grip surfaces and ascending gradients, as well as a hill descent function that controls vehicle speed on steeper inclines.

On All Wheel Drive vehicles fitted with Adaptive Dynamics², optional Adaptive Surface Response (AdSR) recognises differences between surfaces to exploit the maximum available grip. Drawing on Jaguar Land Rover's unrivalled expertise with All Wheel Drive systems, AdSR constantly monitors the car's environment and adjusts the appropriate engine and brake settings. Once selected, AdSR works at all speeds to support you in adverse weather and across challenging surfaces.

¹Automatic transmission only.

²Standard on XF S, not available on 2.0 litre 4-cylinder 163PS Diesel engine.

With any given set of tyres, ASPC can accomplish comparable levels of traction to that achievable by an expert driver. Fitting All-season or Winter tyres to XF can improve capability on slippery surfaces.

GRAVEL



WET GRASS



SNOW/ICE



WET ROAD



HBS 991

XE



ADVANCED DRIVETRAIN TECHNOLOGY



ALL WHEEL DRIVE

INTELLIGENT DRIVELINE DYNAMICS

XF's All Wheel Drive (AWD) system combines the agility and character of Rear Wheel Drive (RWD) with the increased security and traction provided by AWD. In normal driving, XF is predominantly RWD to deliver handling purity, feel and balance. But when roads become more challenging, or when you accelerate more keenly on low-grip surfaces, the system subtly channels power forwards enabling XF to maintain optimum traction for comfortable progress in all conditions.

XF's AWD uses a transfer case at the back of the 8-speed Automatic Transmission to manage the appropriate distribution of torque to the front and rear wheels. Engineered to ensure that XF retains the dynamic behaviour of a Jaguar, the transfer case contains an electro-mechanically activated multi-plate clutch with an actuator to build hydraulic pressure. This pressure is quickly and accurately controlled to generate the required force in the clutch to transfer the optimal amount of torque to the front wheels.

Unlike other systems that react to wheel slip, Jaguar's Intelligent Driveline Dynamics (IDD) software is predictive and uses sensors measuring throttle and steering inputs to anticipate wheel slip. IDD seamlessly co-ordinates these inputs and compares them with responses from the engine, transmission and traction control systems to calculate the traction available and distribute torque accordingly even before grip is lost. From a standstill XF can transition from RWD to AWD in as little as 165 milliseconds or just 100 milliseconds when the car is moving. The result is a drive which blends the character of RWD with the capability of AWD, providing outstanding levels of performance and control whatever the road throws at you.

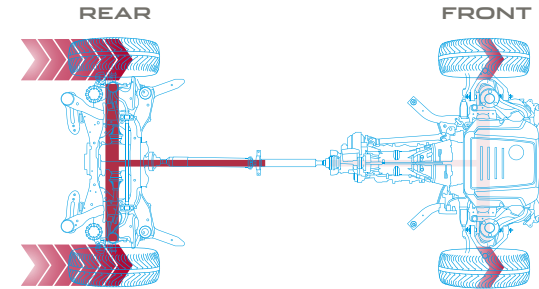

DRY ROAD CONDITIONS

In normal conditions, torque is distributed to the rear wheels, delivering acclaimed Jaguar agility and handling.

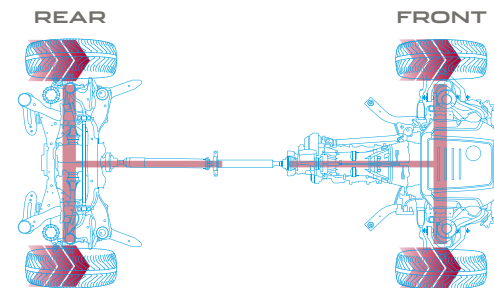

LOW TRACTION CONDITIONS

On slippery surfaces, such as grass and snow, torque can be balanced between the front and rear wheels to maximise traction. In extreme conditions where only the front wheels have traction, up to 100 percent of engine torque can be distributed to the front wheels for optimum grip.

VEHICLE SHOWN: XF SALOON S IN YULONG WHITE WITH OPTIONAL FEATURES FITTED (MARKET DEPENDENT)



TORQUE VECTORING

➤ MAXIMISED CORNERING CAPABILITY

XF's Torque Vectoring by Braking maximises capability through even the tightest corners. Torque Vectoring technology provides controlled independent braking on the individual inside front and rear wheels to add to the turning forces acting on the car. In most conditions more braking pressure is applied to the rear inside wheel as this supports the most increased cornering capability, while the front inside wheel is braked for greater effectiveness and refinement. The result is reduced understeer for sharper turning and more consistent road holding. Torque Vectoring delivers increased sports car-like agility and added driver confidence.

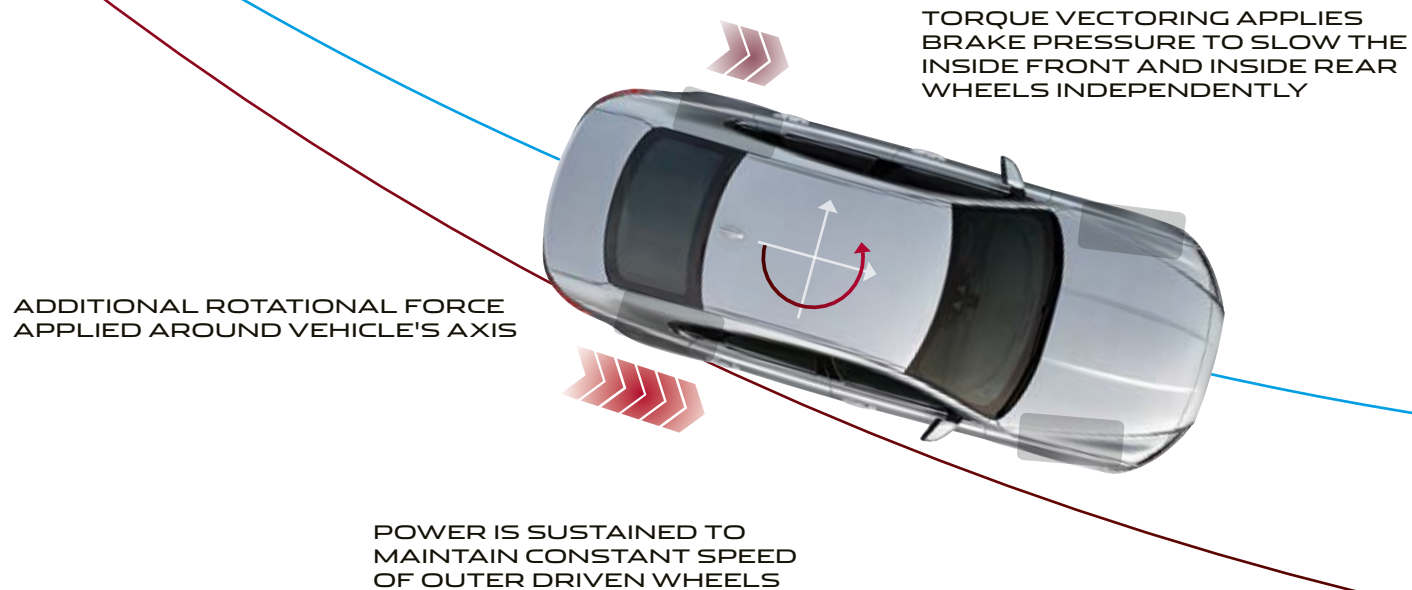

Graphical representation only.

VEHICLE SHOWN PREVIOUS PAGE: XF SALOON S IN YULONG WHITE WITH OPTIONAL FEATURES FITTED (MARKET DEPENDENT)



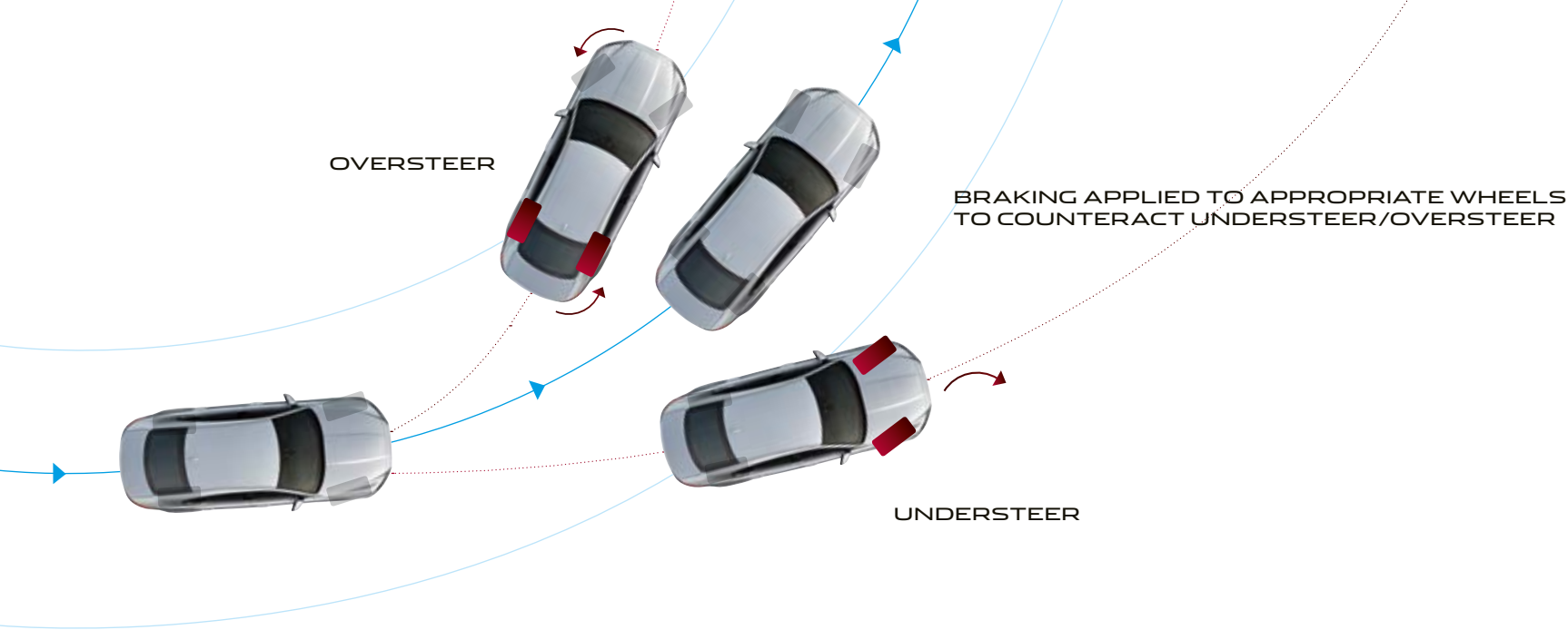

STABILITY AND CONTROL



**DYNAMIC
STABILITY CONTROL**

**ENGINE DRAG
TORQUE CONTROL**

**TRAILER
STABILITY ASSIST**

Jaguar's Stability Systems keep XF safely balanced whether you're driving enthusiastically or simply want the assurance of a car that will remain stable in challenging conditions.

Dynamic Stability Control (DSC) monitors XF's dynamic behaviour, intervening to maximise vehicle stability and optimising available grip. DSC reduces engine torque and applies braking to the appropriate wheels to correct the car's direction of travel by counteracting understeer or oversteer. XF's DSC system has enhanced understeer control to reduce speed and regain control more effectively.

Engine Drag Torque Control (EDC) mitigates the chance of wheel lock-up caused by strong engine braking in slippery conditions. It acts by briefly increasing torque to the driven wheels as appropriate.

Trailer Stability Assist (TSA) gives you greater stability when towing. Should TSA detect a dangerous trailer sway situation is developing, it can help you regain control by gradually reducing XF's speed through lowering engine power and applying the brakes individually on each side of the vehicle to control the sway.

Graphical representation only.

VEHICLE SHOWN PREVIOUS PAGE: XF SALOON S IN YULONG WHITE WITH OPTIONAL FEATURES FITTED (MARKET DEPENDENT)



HOME 2:56 PM

Navigation Arlington Avenue Leamington Spa 65km 4:55 PM	Media Bluetooth audio Young Before Your Time Corvidae	Phone My iPhone
--	--	--------------------

15 16.5

SYNC WIPER TRIP RESET AUTO

MAX WIPER MAX A/C A/C

START/STOP ENGINE

P R N D S

DRIVE MODE SELECTOR

TECHNOLOGY INFOTAINMENT

Delivering a wealth of information and entertainment, every XF is equipped with our InControl infotainment system, Touch Pro. It features intuitive and advanced integrated technologies to ensure everyone can make the most of their journey.



10" TOUCH PRO

The standard 10" Touchscreen at the heart of the centre console supports tap, swipe and pinch to zoom gestures and delivers our richest ever audio-visual entertainment. To enhance the in-car experience, Touch Pro offers customisable homescreens and fast response times as well as voice control. Multi-tasking is also made easy thanks to the Interactive Side Panel. Touch Pro can be further enhanced by adding the connectivity package, Connect Pro¹.



INTERACTIVE DRIVER DISPLAY

The optional 12.3" high-definition Interactive Driver Display¹ can receive and project a vast amount of driving information, entertainment and active safety data including navigation, phone and media. Its high resolution ensures the utmost clarity and its refined processing engine delivers smooth moving pin sharp graphics. To help you find your way more easily, the option of Navigation Pro² enables you to display full screen navigation with 3D mapping.



HEAD-UP DISPLAY

To help reduce distraction or the need for you to take your eyes off the road, Head-up Display³ is an option that presents key vehicle data such as your speed, gear position and navigation directions on the windscreen. It features crystal clear full-colour graphics in high resolution, enabling you to see all driver inputs and information with ease. It can display important information from the Touch Pro Touchscreen and your phone. The feature can be turned on and off dependent on driver preference.

¹Requires Navigation Pro.

²Requires Connect Pro Pack.

³Requires Solar attenuating windscreen to be fitted.

Remote contains subscription services that can be extended after the initial term advised by your Jaguar Retailer. InControl features, options and their availability remain market dependent - check with your Jaguar Retailer for local market availability and full terms. Information and images displayed in relation to the InControl technology, including screens or sequences, are subject to software updates, version control and other system/visual changes depending on options selected. Mobile network connectivity cannot be guaranteed in all locations. InControl Apps and Remote App will need to be downloaded from the Apple/Play Store. All in-car features should be used by drivers only when safe for them to do so. Drivers must ensure they are in full control of the vehicle at all times.

CONNECTIVITY

InControl is Jaguar's suite of standard and optional features that connects you to your vehicle and links you seamlessly, and securely, with the outside world. There are a range of packs and options available to choose from. With a selection of apps, even when you're away from your car, some of the InControl features stay with you, making sure the Jaguar experience is more enjoyable than ever.

STANDARD FEATURES

PINPOINT TOUCH CONTROL

Pinpoint touch control allows you to interact with information swiftly. The Touchscreen responds in the same manner as a smartphone or tablet computer, providing multi-touch gestures such as pinch to zoom and swipe.

PERSONALISED HOMEPAGE

You can set up your homescreens the way you want them. With over 60 shortcuts and widgets, you can customise your system around the features you use most.

INTERACTIVE SIDE PANEL

A choice of side panels means you can multi-task. For example, your main screen area can be used for navigation, while the side panel provides phone controls. Simply swipe up and down to switch between multiple panels.

MULTIMEDIA

Enjoy a range of multimedia features on the Touchscreen. Connect your device and see details of playlists and music displayed by artist, album and genre.

ENHANCED PHONE INTERFACE

Making it easier and safer, you can call a favourite contact with a single touch via the customisable homepage. Additional functionality includes direct access to voicemail, conference calling and homescreen integration.

VOICE RECOGNITION SYSTEM

So you can complete tasks without taking your eyes off the road, XF offers intelligent voice recognition. For example, 'Tune to 97.9' or 'Call home'.

Remote contains subscription services that can be extended after the initial term advised by your Jaguar Retailer. InControl features, options and their availability remain market dependent - check with your Jaguar Retailer for local market availability and full terms. Information and images displayed in relation to the InControl technology, including screens or sequences, are subject to software updates, version control and other system/visual changes depending on options selected. Mobile network connectivity cannot be guaranteed in all locations. InControl Apps and Remote App will need to be downloaded from the Apple/Play Store. All in-car features should be used by drivers only when safe for them to do so. Drivers must ensure they are in full control of the vehicle at all times.



PROTECT

Jaguar Optimised Assistance¹ – If you break down you can make a direct call to the Jaguar Assistance team by pressing the button on the overhead console or from the Assistance screen within the Remote smartphone app.

SOS Emergency Call – In a more serious incident, SOS Emergency Call will automatically connect you to the emergency response team who will notify the emergency services to your location. For peace of mind, this service is provided for the first ten years from date of registration.

Remote Essentials – Remote smartphone app provides information on your vehicle and enables you to interact with it remotely. Compatible with most smartphones, Android Wear™ or the Apple Watch®, this service includes:

- **Journey Tracking** – This opt-in feature can automatically record your journey history including your route and mileage statistics. This information can be exported by email to use for expense reporting and can be imported to a spreadsheet.
- **Vehicle Status Check** – Check current fuel level and range, and status of door and window position and locks. See the last parked location of the vehicle and find your way back to it with on-foot directions.

SMARTPHONE PACK²

By screen sharing with XF's InControl infotainment system, the Smartphone Pack helps you stay connected to your smartphone even while in the car.

Android Auto™ was designed with safety in mind. With a simple and intuitive interface, it is designed to minimise distraction so that you can stay focused on the road.

Simply connect your Android smartphone via a USB and control compatible apps on the in-car Touchscreen.

Apple CarPlay® is also designed for increased safety, enabling the use of apps while allowing the driver to concentrate on the road ahead. Connect your Apple smartphone to your car to use compatible apps such as maps, messages and music through the Touchscreen.

¹Jaguar Optimised Assistance is a subscription service that can be extended after the initial term advised by your Jaguar Retailer.

²Features within Smartphone Pack may vary between markets.

OPTIONAL FEATURES

NAVIGATION PRO¹

Navigation Pro allows you to save your favourite places, use swipe and pinch to zoom gestures for simple map exploration and display a choice of either 2D or 3D crystal clear map graphics. Navigation Pro functionality is further enhanced by the Connect Pro Pack.

CONNECT PRO PACK²

Connect Pro consists of InControl Apps, Remote Premium, a 4G Wi-Fi Hotspot, Pro Services and Connected Navigation. It's designed to enhance your in-car and out-of-car experience, ensuring you and your passengers enjoy the journey whilst remaining connected to the world.

INCONTROL APPS

Jaguar InControl Apps technology allows vehicle-optimised apps on your Android™ or Apple smartphone to be controlled through the vehicle's Touchscreen, including contacts, calendar and music player via a USB cable. You can also download third-party apps offering a range of services.

- **Spotify³** – Access a library of more than 30 million songs with this seamlessly integrated app. Featuring all the same intuitive functionality as the Spotify smartphone app, you can search songs, stations and recommendations, create playlists and access your music in offline mode. Simply log in using your existing Spotify Free or Spotify Premium account.
- **Tile⁴** – Helps you find lost or misplaced items in seconds. Attach a tiny Bluetooth tracker Tile to your keys, wallet or bag. The easy-to-use Tile app can then help you find these items should they be misplaced. The app is accessible any time through your vehicle's Touchscreen, allowing you to make sure you have everything you need with you, before you set off on your journey.

REMOTE PREMIUM

Remote Premium provides the following enhancements to the Remote Essentials smartphone app:

- **Remote Lock/Unlock** – Lock or unlock your doors remotely with the click of a button. Simply press the 'lock' button on the Vehicle Security screen of the Remote smartphone app to single lock the doors, arm the alarm, fold in the wing mirrors⁵ and close the windows. Press the 'unlock' button to unfold the wing mirrors, turn on the dipped headlights and cause the hazard lights to flash twice.

- **Remote Climate** – Prepare your XF in advance by pre-heating or pre-cooling the cabin, so that you and your passengers are comfortable from the moment you step inside.
- **Beep/Flash** – This feature turns on your Jaguar's hazard lights, dipped headlights and sounds an audible alert to help you locate your vehicle in a crowded car park.

4G Wi-Fi

The 4G Wi-Fi Hotspot provides in-car access to the Internet, enabling up to eight wireless devices to be used simultaneously in the car. Passengers can connect through the vehicle's wireless network to surf, work, update social media and stay entertained throughout the journey.

PRO SERVICES

- **Real Time Traffic Information** – Uses live traffic data feeds to give you the most accurate picture of what the traffic is like on the way to your destination.
- **One-box Search** – Wherever you are, you can search the surrounding area for places of interest. The system can access expert destination information, travel tips and inspiration as well as online travel reviews of the local area.
- **Planning Routes and Door-to-Door Routing** – Before setting off, use the Route Planner app or online portal to search, save locations or set your destination. The app uses the Cloud to send your destination automatically to your vehicle's navigation screen. Once you've parked, the Route Planner app will guide you to your destination – a true door-to-door experience which includes public transport options.
- **Satellite View** – When you want to get the context of your surroundings from overhead, simply switch to satellite view.
- **Commute Mode** – Allows the system to learn your commutes and automatically advises you of the expected journey time based on live and historical traffic movements without you having to input a destination. The system learns the routes you take for a given destination and the advises which of those is the quickest. The feature can be turned on and off dependent on driver preference.

Remote contains subscription services that can be extended after the initial term advised by your Jaguar Retailer. InControl features, options and their availability remain market dependent – check with your Jaguar Retailer for local market availability and full terms. Information and images displayed in relation to the InControl technology, including screens or sequences, are subject to software updates, version control and other system/visual changes depending on options selected. Mobile network connectivity cannot be guaranteed in all locations. InControl Apps and Remote App will need to be downloaded from the Apple/Play Store. All in-car features should be used by drivers only when safe for them to do so. Drivers must ensure they are in full control of the vehicle at all times.

- **Parking Service** – As you approach your destination, you can see where parking is available. Simply tap on your preferred car park and the navigation system updates to direct you to it.
- **Online Routing** – While you're on your way to a destination the system monitors live traffic conditions and takes into account typical traffic patterns for that time of day, keeping you on the optimum route.
- **Safety Cameras** – Alerts you to the location of accident black spots monitored by safety cameras.
- **Fuel Prices** – When you're going to fill up, the Fuel Price service not only finds filling stations along your route, it also enables you to compare fuel prices so you can keep your costs down.
- **Online Media** – Allows for the aggregation of numerous content providers and their personalised content – such as Deezer and Tuneln – that gives access to more than 40 million music tracks and four million on-demand programmes and podcasts. For the first time, these can be directly streamed from the vehicle without the need for a smartphone – providing a seamless and integrated experience.

SECURE TRACKER⁶

Uses tracking technology to alert you to an attempted theft, and signals your vehicle's location to the relevant authorities, for a timely recovery. Includes service subscription for warranty period.



¹Requires Connect Pro.

²Requires Navigation Pro.

³Please check App Store and Google Play for availability.

⁴Bluetooth tracker tiles must be purchased separately. 2016 Tile Inc. and the Tile design are trademarks of Tile, Inc.

⁵When power fold mirrors are specified.

⁶Secure Tracker will require further subscription after the initial term as advised by your Jaguar Retailer.

AUDIO

A vehicle's cabin is the ideal place within which to experience your personal choice of music and Jaguar XF has the option of three different audio systems to bring your music to life:



SOUND SYSTEM

Excellent acoustic range through eight speakers.

MERIDIAN™ SOUND SYSTEM*

Great definition, crystal clear highs and full, deep bass – delivered through the careful arrangement of 10 speakers and a dual channel subwoofer.

MERIDIAN SURROUND SOUND SYSTEM*

All the fullness and clarity of a live performance delivered through an arrangement of 16 front, side and rear speakers and a dual channel subwoofer – seamlessly brought together using Trifield™ technology. Exclusive to Meridian, Trifield perfectly blends the centre and surround channels with left and right channels ensuring an optimum, consistent sound experience for each passenger.

DIGITAL AUDIO BROADCAST (DAB) RADIO*







The option of DAB radio technology offers improved sound quality, a wide choice of stations and live text information about the station, show and song you are listening to.

*Optional feature.

Image is representative of Meridian Surround Sound System.

MERIDIAN™

Formed in 1977 in Cambridgeshire, England, Jaguar’s audio partner Meridian has pioneered many firsts including active speakers and the world’s first digital surround sound processor. Meridian’s audio technology input has helped ensure that Jaguar XF is the most superb space within which to experience sound. Meridian Cabin Correction technology was utilised to analyse cabin shape, acoustics and resonance characteristics in order to help remove unwanted sounds. The advanced algorithm ensures that the rhythm, punch and timing of any piece of music are heard precisely how the artist intended, providing a consistently exceptional quality audio experience for all passengers in the vehicle.

	UNIQUE MERIDIAN TECHNOLOGY	SPEAKERS + SUBWOOFER	WATTS
SOUND SYSTEM	N/A	8	180
MERIDIAN™ SOUND SYSTEM	  	10+1	380
MERIDIAN™ SURROUND SOUND SYSTEM	   	16+1	825



DIGITAL SIGNAL PROCESSING

Brings all elements of the audio system together as one, for performance that would otherwise require significantly larger speakers.



MERIDIAN CABIN CORRECTION

The advanced algorithm of Meridian’s Cabin Correction tailors the sound experience to the precise acoustics of XF’s interior.



MERIDIAN DIGITAL DITHER SHAPING

To maintain the quality of musical recordings, they are converted into a common digital format. Meridian Digital Dither Shaping ensures that digital signal conversions are made smoothly and seamlessly, preserving the finest details of the audio performance. The result is authentic musical conversion, evoking the emotions of the original recording.



TRIFIELD

Exclusive to Meridian, Trifield blends the centre and surround channels seamlessly with left and right channels, delivering a consistent, concert-like experience for all occupants.

Meridian is a registered trademark of Meridian Audio Ltd.
Trifield and the “three fields” device is a trademark of Trifield Productions Ltd.
Features and their availability may differ by vehicle specification and market.

SAFETY AND EFFICIENCY DRIVER ASSISTANCE

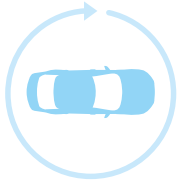

360° SURROUND CAMERA

360° Surround Camera uses four digital cameras discretely placed around the vehicle, providing a 360° birds eye view on the Touchscreen. With the capacity to display several different views at the same time, this helps with various manoeuvres from parking by a kerb, to getting in and out of tight spaces and junctions.



REAR CAMERA

Rear Camera provides improved visibility when reversing. Static lines representing the vehicle's outer perimeter and predicted path are superimposed on the rear view image displayed on your Touchscreen.

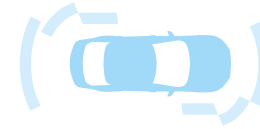

360° PARKING AID

360° Parking Aid uses ultrasonic sensors to the front, rear and sides of the vehicle to alert you to the proximity of objects when parking or exiting from a bay.



AUTONOMOUS EMERGENCY BRAKING

Should a potential collision be detected, XF gives an audible forward collision warning. Visual warnings follow. If the driver takes no action, the system applies the brakes to help reduce the severity of the possible impact.



FRONT AND REAR PARKING AIDS

Front and Rear Parking Aids make manoeuvring even easier. Sensors located in the front and rear bumpers are activated manually, or when reverse is selected. As you park, the Touchscreen display and audio feedback indicates how close you are to obstacles.

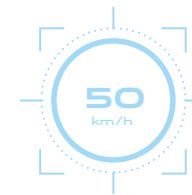

TRAFFIC SIGN RECOGNITION AND ADAPTIVE SPEED LIMITER

Traffic Sign Recognition technology detects speed limits, including variable limits, and no overtaking signs via the forward-facing camera, then displays them to the driver. The Adaptive Speed Limiter uses detected traffic sign information to help keep XF within the appropriate speed limit. Where no traffic sign is detected, the Adaptive Speed Limiter can also use the map data from the optional navigation guidance system.

All in-car features should be used by drivers only when safe for them to do so. Drivers must ensure they are in full control of the vehicle at all times. For more details on feature availability refer to page 67 or configure your vehicle at jaguar.com



BLIND SPOT ASSIST AND REVERSE TRAFFIC DETECTION

Blind Spot Assist can help you prevent collisions. If your vehicle detects another car in your blind spot when you begin to change lanes, a small warning light illuminates in the corresponding wing mirror. Corrective torque is also applied to the steering wheel, encouraging you to guide your vehicle away from the approaching vehicle. Reverse Traffic Detection is particularly useful when reversing out of a parking bay, the system warns you of vehicles, pedestrians or other hazards, approaching from either side of your vehicle. It will alert you with both audio and visual warnings so you know what's behind you even when the view is obstructed.



PEDESTRIAN CONTACT SENSING

Help protect the people outside your car as well as those inside. If the car makes contact with a pedestrian, our industry leading Pedestrian Contact Sensing system is designed to automatically raise the bonnet to help cushion a potential impact.



LANE KEEP ASSIST AND DRIVER CONDITION MONITOR

Lane Keep Assist detects when the vehicle is unintentionally drifting out of the lane, and applies a corrective torque to the steering wheel, encouraging you to guide your vehicle back. Driver Condition Monitor detects if you're starting to feel drowsy and gives you an early warning when you need to take a break.

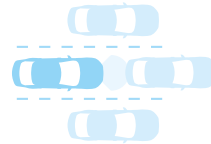

ADAPTIVE CRUISE CONTROL WITH QUEUE ASSIST

Adaptive Cruise Control uses radar technology to automatically adjust your speed to maintain a safe distance from the vehicle ahead. XF resumes its pre-set speed as soon as the road in front is clear. Should the car in front stop completely, the Queue Assist function brings XF to a smooth halt. Once the traffic moves off, touch the accelerator and XF will follow the car in front again.

PERSONALISATION XF - YOUR CHOICE

 Configure your vehicle at jaguar.com



CHOOSE YOUR ENGINE

Page 54

Select one of XF's powerful, efficient petrol or diesel engines to suit your driving style.

CHOOSE YOUR MODEL & OPTIONS

Page 62

Compare the wealth of standard features and options on XF models.

CHOOSE YOUR COLOUR

Page 72

Express your individuality with one of XF's stunning exterior colours.

CHOOSE YOUR WHEELS

Page 74

Add the personal finishing touch to your new XF, and complement its stunning style, with a set of beautifully designed alloy wheels.

CHOOSE YOUR INTERIOR

Page 76

There's a wide selection of premium materials, leathers, veneers and finishes for every personal taste.

CHOOSE YOUR JAGUAR GEAR - ACCESSORIES

Page 94

Really make it yours by adding style, practicality and versatility with official XF Gear Accessories from your local Jaguar Retailer.

1 CHOOSE YOUR ENGINE

 Configure your vehicle at jaguar.com

> DIESEL ENGINES

2.0 LITRE

4-CYLINDER TURBOCHARGED E-PERFORMANCE

XF SALOON	XF SPORTBRAKE
MAXIMUM POWER 163PS	MAXIMUM POWER 163PS
MAXIMUM TORQUE 380Nm	MAXIMUM TORQUE 380Nm
ACCELERATION 0-100km/h Manual RWD 9.8 seconds Automatic RWD 9.1 seconds	ACCELERATION 0-100km/h Manual RWD 10 seconds Automatic RWD 9.3 seconds
TOP SPEED Manual RWD 229km/h Automatic RWD 227km/h	TOP SPEED Manual RWD 219km/h Automatic RWD 219km/h
PURE, PRESTIGE, PORTFOLIO, R-SPORT	PURE, PRESTIGE, PORTFOLIO, R-SPORT

2.0 LITRE

4-CYLINDER TURBOCHARGED

XF SALOON	XF SPORTBRAKE
MAXIMUM POWER 180PS	MAXIMUM POWER 180PS
MAXIMUM TORQUE 430Nm	MAXIMUM TORQUE 430Nm
ACCELERATION 0-100 km/h Manual RWD 9.2 seconds Automatic RWD 8.4 seconds Automatic AWD 8.5 seconds	ACCELERATION 0-100km/h Automatic RWD 8.5 seconds Automatic AWD 8.6 seconds
TOP SPEED Manual RWD 230km/h Automatic RWD 229km/h Automatic AWD 222km/h	TOP SPEED Automatic RWD 221km/h Automatic AWD 219km/h
PURE, PRESTIGE, PORTFOLIO, R-SPORT, CHEQUERED FLAG	PURE, PRESTIGE, PORTFOLIO, R-SPORT, CHEQUERED FLAG



MANUAL
0-100 KM/H



AUTOMATIC
0-100 KM/H



MANUAL
0-100 KM/H



AUTOMATIC
0-100 KM/H



MANUAL RWD
0-100 KM/H



AUTOMATIC RWD
0-100 KM/H



AUTOMATIC AWD
0-100 KM/H



AUTOMATIC RWD
0-100 KM/H



AUTOMATIC AWD
0-100 KM/H



MANUAL
TOP SPEED KM/H



AUTOMATIC
TOP SPEED KM/H



MANUAL
TOP SPEED KM/H

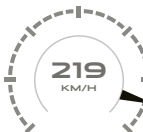

AUTOMATIC
TOP SPEED KM/H



MANUAL
TOP SPEED KM/H



AUTOMATIC RWD
TOP SPEED KM/H



AUTOMATIC AWD
TOP SPEED KM/H



AUTOMATIC RWD
TOP SPEED KM/H



AUTOMATIC AWD
TOP SPEED KM/H

Please refer to the accompanying Technical Specification for full details on Drive line, Engine Performance and Fuel Economy.

2.0 LITRE

4-CYLINDER TWIN TURBOCHARGED

XF SALOON

MAXIMUM POWER 240PS

MAXIMUM TORQUE 500Nm

ACCELERATION 0-100km/h
Automatic AWD 6.9 seconds

TOP SPEED

Automatic AWD 246km/h

PURE, PRESTIGE, PORTFOLIO,
R-SPORT, CHEQUERED FLAG

XF SPORTBRAKE

MAXIMUM POWER 240PS

MAXIMUM TORQUE 500Nm

ACCELERATION 0-100km/h
Automatic AWD 7 seconds

TOP SPEED

Automatic AWD 241km/h

PRESTIGE, PORTFOLIO,
R-SPORT, CHEQUERED FLAG

3.0 LITRE V6

6-CYLINDER TWIN TURBOCHARGED

XF SALOON

MAXIMUM POWER 300PS

MAXIMUM TORQUE 700Nm

ACCELERATION 0-100km/h
Automatic RWD 6.4 seconds

TOP SPEED

Automatic RWD 250km/h

PRESTIGE, PORTFOLIO,
R-SPORT, CHEQUERED FLAG, S

XF SPORTBRAKE

MAXIMUM POWER 300PS

MAXIMUM TORQUE 700Nm

ACCELERATION 0-100km/h
Automatic RWD 6.6 seconds

TOP SPEED

Automatic RWD 250km/h

PORTFOLIO, S



AUTOMATIC AWD
0-100 KM/H



AUTOMATIC AWD
0-100 KM/H



AUTOMATIC RWD
0-100 KM/H



AUTOMATIC RWD
0-100 KM/H



AUTOMATIC AWD
TOP SPEED KM/H



AUTOMATIC AWD
TOP SPEED KM/H

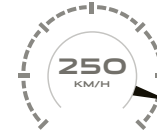

AUTOMATIC RWD
TOP SPEED KM/H



AUTOMATIC RWD
TOP SPEED KM/H

1 CHOOSE YOUR ENGINE

 Configure your vehicle at jaguar.com

> PETROL ENGINES

2.0 LITRE

4-CYLINDER TURBOCHARGED

XF SALOON	XF SPORTBRAKE
MAXIMUM POWER 250PS	MAXIMUM POWER 250PS
MAXIMUM TORQUE 365Nm	MAXIMUM TORQUE 365Nm
ACCELERATION 0-100km/h Automatic RWD 6.7 seconds	ACCELERATION 0-100km/h Automatic RWD 6.9 seconds
TOP SPEED Automatic RWD 244km/h	TOP SPEED Automatic RWD 241km/h
PURE, PRESTIGE, PORTFOLIO, R-SPORT, CHEQUERED FLAG	PURE, PRESTIGE, PORTFOLIO, R-SPORT, CHEQUERED FLAG

2.0 LITRE

4-CYLINDER TURBOCHARGED

XF SALOON	XF SPORTBRAKE
MAXIMUM POWER 300PS	MAXIMUM POWER 300PS
MAXIMUM TORQUE 400Nm	MAXIMUM TORQUE 400Nm
ACCELERATION 0-100km/h Automatic AWD 5.9 seconds	ACCELERATION 0-100km/h Automatic AWD 6 seconds
TOP SPEED Automatic AWD 250km/h	TOP SPEED Automatic AWD 250km/h
PURE, PRESTIGE, PORTFOLIO, R-SPORT, CHEQUERED FLAG	PRESTIGE, PORTFOLIO, R-SPORT, CHEQUERED FLAG



AUTOMATIC RWD
0-100 KM/H



AUTOMATIC RWD
0-100 KM/H



AUTOMATIC AWD
0-100 KM/H



AUTOMATIC AWD
0-100 KM/H



AUTOMATIC RWD
TOP SPEED KM/H



AUTOMATIC RWD
TOP SPEED KM/H



AUTOMATIC AWD
TOP SPEED KM/H



AUTOMATIC AWD
TOP SPEED KM/H

*Please refer to the accompanying Technical Specification for full details on Drive line, Engine Performance and Fuel Economy.

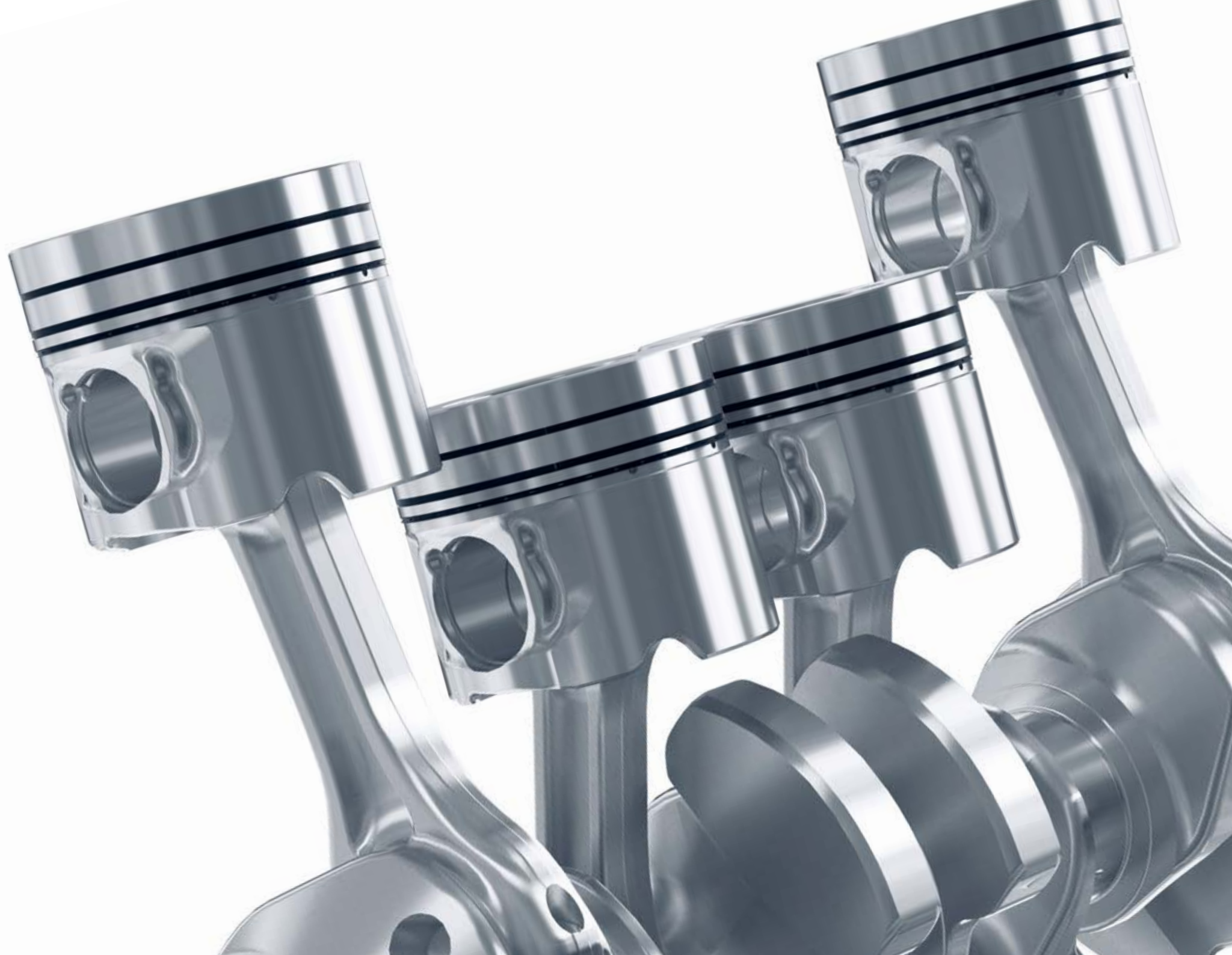



NEW XF CHEQUERED FLAG SALOON AND SPORTBRAKE

With all the style, elegance and luxury of XF, Chequered Flag bears testimony to Jaguar's undoubted heritage. Building on the assertive design of R-Sport, Gloss Black side vents feature unique badging, whilst the sleek 'S' bumpers enhance XF's purposeful stance. Unique wheels, together with the Black Pack trimmed exterior, give it an even greater presence. XF is refined and contemporary, but it's also from pure racing pedigree. Ease into the R-Sport styled cockpit, grip the soft grain leather steering wheel and simply relish being on the road.

Features:

- A choice of petrol and diesel engines* • Rear Wheel Drive (RWD) or All Wheel Drive (AWD)

Exterior:

- Available in Yulong White, Santorini Black and Eiger Grey • Assertive Black Pack design styling • Tailgate/boot lid spoiler
- Sport-inspired 'S' bumpers with body-coloured cheeks • Gloss black Chequered Flag side vents to match the finish of the 18" Style 7011, 7 split-spoke wheels • Body-coloured side sills

Interior:

- A choice between Ebony/Pimento or Ebony/Ebony grained leather interior with contrast stitching • Perforated grained leather seats with contrast stitching • Metal treadplates with Chequered Flag branding • Soft grain leather steering wheel with Chrome gearshift paddles • Dark Hex Aluminium instrument panel finisher • Keyless Entry • Navigation Pro • Connect Pro • Interactive Driver Display.

*For further details please see pages 54-56.



2 CHOOSE YOUR MODEL

 Configure your vehicle at jaguar.com

> LUXURY



PURE

KEY FEATURES

17" alloy wheels (18" alloy wheels on V6 engines and 2.0 litre 4-cylinder 300PS Petrol engine)

10" Touch Pro

Premium fabric seats

10-way electric front seats¹

Gloss Black veneer

Morse Code Aluminium instrument panel finisher

All Surface Progress Control (automatic transmission only)

Front and Rear Park Aid

Premium carpet mats

Suedecloth headlining

XF SPORTBRAKE KEY FEATURES (IN ADDITION TO SALOON)

Integrated roof rails

Integrated roof spoiler

Rear self-levelling air suspension

Automatic loadspace cover

40:20:40 split fold rear seats

Powered tailgate

Stainless steel loadspace scuff plate



PRESTIGE

KEY FEATURES (IN ADDITION TO PURE)

Xenon headlights with LED 'J' blade Daytime Running Lights and power wash

Grained leather seats

Rear armrest with cupholders²

Soft grain leather sport steering wheel

Ambient Interior Lighting

XF SPORTBRAKE KEY FEATURES (IN ADDITION TO SALOON)

Integrated roof rails

Integrated roof spoiler

Rear self-levelling air suspension

Automatic loadspace cover

40:20:40 split fold rear seats

Powered tailgate

Stainless steel loadspace scuff plate



PORTFOLIO

KEY FEATURES (IN ADDITION TO PRESTIGE)

18" alloy wheels (17" alloy wheels on 2.0 litre 4-cylinder 163PS Diesel engine)

Windsor leather seats

Windsor leather instrument panel finisher

Gloss Figured Ebony veneer

XF SPORTBRAKE KEY FEATURES (IN ADDITION TO SALOON)

Integrated roof rails

Integrated roof spoiler

Rear self-levelling air suspension

Automatic loadspace cover

40:20:40 split fold rear seats

Powered tailgate

Stainless steel loadspace scuff plate

¹8-way manual front seats with electric recline standard on XF Pure 2.0 litre 4-cylinder 163PS Diesel engine.

²Standard on all XF Sportbrake models. ³Boot mounted spoiler only available on XF Saloon. ⁴XF Saloon only.

Images feature optional equipment. Please note that standard features may be replaced when selecting alternative trim levels.

Standard features may also vary depending on country of purchase, engine variant and transmission, please refer to Specification and Price Guide or website for your local market.

> SPORT



R-SPORT

KEY FEATURES (IN ADDITION TO PRESTIGE)

- 18" alloy wheels (17" alloy wheels on 2.0 litre 4-cylinder 163PS Diesel engine)
- R-Sport body kit including sports front bumper, side sills and boot mounted spoiler³
- Sports suspension (only available on Ingenium 2.0 litre Petrol 250PS RWD engine and Ingenium Diesel 180PS and 240PS⁴ RWD engines)
- Sports grained leather seats with Technical Mesh inserts
- Multi-function steering wheel with R-Sport branding
- Gloss Black side window surround
- Dark Morse Code Aluminium instrument panel finisher

XF SPORTBRAKE KEY FEATURES (IN ADDITION TO SALOON)

- Gloss Black roof rails
- Integrated roof spoiler
- Rear self-levelling air suspension
- Automatic loadspace cover
- 40:20:40 split fold rear seats
- Powered tailgate
- Stainless steel loadspace scuff plate



S

KEY FEATURES (IN ADDITION TO R-SPORT)

- 19" alloy wheels
- S body kit including sports front bumper, Gloss Black side sills, rear valance and boot mounted spoiler⁴
- Red brake calipers
- Sports grained leather S embossed seats with suedecloth inserts
- Grey Figured Ebony veneer
- Dark Hex Aluminium instrument panel finisher
- Multi-function steering wheel with S branding
- Adaptive Dynamics

XF SPORTBRAKE KEY FEATURES (IN ADDITION TO SALOON)

- Gloss Black roof rails
- Integrated roof spoiler
- Rear self-levelling air suspension
- Automatic loadspace cover
- 40:20:40 split fold rear seats
- Powered tailgate
- Stainless steel loadspace scuff plate

2 CHOOSE YOUR OPTIONS

 Configure your vehicle at jaguar.com

KEY STANDARD FEATURES

	PURE	PRESTIGE	PORTFOLIO	R-SPORT	S	DESCRIPTION
Intelligent Stop/Start system	●	●	●	●	●	Refer to page 22
Hill Launch Assist	●	●	●	●	●	Prevents your XF from rolling backwards when pulling away on an incline, helping you to make the perfect hill start every time
JaguarDrive Control with Eco, Dynamic, Normal and Rain/Ice/Snow Mode	●	●	●	●	●	
Electric Power Assisted Steering (EPAS)	●	●	●	●	●	Refer to page 32
Electric Park Brake with drive away release	●	●	●	●	●	Automatically releases the parking brake without the need for driver input as you press the accelerator to drive away
Emergency Brake Assist	●	●	●	●	●	Increases braking pressure in an emergency situation
Autonomous Emergency Braking	●	●	●	●	●	Refer to page 50
Hazard lights under heavy braking	●	●	●	●	●	
Airbags	●	●	●	●	●	Driver and front passenger with seat occupant detector for passenger, front side and full length side window curtain
Torque Vectoring	●	●	●	●	●	Refer to page 39
Dynamic Stability Control and Traction Control	●	●	●	●	●	Refer to page 41
Cruise Control with Speed Limiter	●	●	●	●	●	
Trailer Stability Assist	●	●	●	●	●	Intervenes when the system detects sway or potentially dangerous movement to bring the trailer back under control
Electric front and rear windows with one-touch open/close and anti-trap	●	●	●	●	●	
Rain sensing windscreen wipers	●	●	●	●	●	
Body-coloured, heated, electric exterior door mirror	●	●	●	●	●	
Two-zone Climate Control	●	●	●	●	●	
10" Touch Pro	●	●	●	●	●	Refer to page 44-47
USB, Auxiliary socket and iPod® connectivity	●	●	●	●	●	Refer to page 44-47
Bluetooth® telephone connectivity	●	●	●	●	●	Refer to page 44-47
Bluetooth® streaming	●	●	●	●	●	Refer to page 44-47
Jaguar Smart Key System – Keyless Start	●	●	●	●	●	
Partial LED tail lights	●	●	●	●	●	
ISOFIX anchor points for rear child seats	●	●	●	●	●	
Heated rear windscreen	●	●	●	●	●	
Power operated child locks	●	●	●	●	●	
Tailgate spoiler (not available on XF Saloon)	●	●	●	●	●	
Rear self-levelling air suspension (not available on XF Saloon)	●	●	●	●	●	Refer to page 8
Loadspace partition net (not available on XF Saloon)	●	●	●	●	●	Refer to page 21

● Standard ○ Option — Not available ■ Part of Pack

Please consult your local Jaguar Retailer for details.

For a complete list of optional features and packs refer to the XF Specification and Price Guide or configure your vehicle at jaguar.com

KEY OPTIONAL FEATURES

		PURE	PRESTIGE	PORTFOLIO	R-SPORT	S	
DYNAMIC FEATURES		CODE					DESCRIPTION
6-speed Manual Transmission with Optimal Shift Indicator (only available on 2.0 litre 4-cylinder Diesel engines)		●	●	●	●	—	
8-speed Automatic Transmission with Jaguar Sequential Shift, gearshift paddles and All Surface Progress Control		○	○	○	○	●	
Sports suspension upgrade (only available on 2.0 litre 4-cylinder Petrol RWD engines and 2.0 litre 4-cylinder Diesel 180PS and 240PS RWD engines. Only available on XF Saloon)		—	—	—	●	—	Adds sports springs and dampers
Adaptive Dynamics (not available on 2.0 litre 4-cylinder 163PS Diesel engine. Includes Configurable Dynamics on automatic transmission)	027CW	○	○	○	○	●	Refer to page 32
Configurable Dynamics (not available with 163PS Diesel engine or manual transmission)	184AB	○	○	○	○	●	Refer to page 32
Adaptive Cruise Control with Queue Assist (requires automatic transmission)	065AG	○	○	○	○	○	Refer to page 51
Adaptive Surface Response (AdSR) (replaces Rain Ice Snow Mode, requires AWD, automatic transmission and Adaptive Dynamics)	088IG	—	○	○	○	—	Refer to page 34
350mm brakes (option only on 2.0 litre 4-cylinder 180PS and 240PS Diesel engines and 2.0 litre 4-cylinder 250PS Petrol engine. Standard on 300PS engines)	020DA	○	○	○	○	●	

EXTERIOR FEATURES AND FINISHERS

EXTERIOR FEATURES AND TRIM							
Electric tilt/slide sunroof (only available on XF Saloon)	041CZ	○	○	○	○	○	
Fixed panoramic roof (only available on XF Sportbrake)	041CX	○	○	○	○	○	Refer to page 21
Full length Gloss Black roof rails (only available on XF Sportbrake)	060BB	—	■	■	●	●	Part of Black Pack
Full length Silver roof rails (only available on XF Sportbrake)	060BA	●	●	●	○	○	Finish of roof rails to match side window surround
Powered tailgate/boot lid	070AV	○	○	○	○	○	Standard on XF Sportbrake
Powered gesture tailgate/boot lid (requires Keyless Entry and Rear Parking Aid)	070BA	○	○	○	○	○	Refer to page 8
Soft door close (requires Keyless Entry)	173AB	○	○	○	○	○	Automatically ensures that doors close softly, securely and with minimum exertion
Chrome radiator grille with Chrome surround	064FR	—	○	○	—	—	
Chrome side window surround	081DA	●	●	●	○	○	
Gloss Black side window surround	081DB	—	■	■	●	●	Part of Black Pack
R-Sport body kit		—	—	—	●	—	Includes R-Sport front bumper, body-coloured side sills and boot lid mounted spoiler (XF Saloon only), Satin Chrome side power vents with R-Sport badge
S body kit		—	—	—	—	●	Includes S front bumper, Gloss Black side sills and rear valance, body-coloured boot lid mounted spoiler (XF Saloon only), Satin Chrome side power vents
Engine de-badge (not available on 2.0 litre 4-cylinder 163PS Diesel engine)	057EV	○	○	○	○	—	Removes engine badging

2 CHOOSE YOUR OPTIONS

 Configure your vehicle at jaguar.com

EXTERIOR FEATURES AND FINISHERS CONTINUED

		PURE	PRESTIGE	PORTFOLIO	R-SPORT	S	
GLASS AND EXTERIOR MIRRORS							DESCRIPTION
Solar attenuating windscreen (front screen only)	047EB	○	○	○	○	○	This windscreen reflects infrared rays, keeping XF's interior cooler
Heated front windscreen with heated washer jets	040AK	○	○	○	○	○	
Privacy glass	047AB	○	○	○	○	○	
Auto-dimming heated door mirrors with power fold and approach lights	030NK	○	○	○	○	○	
HEADLIGHTS AND LIGHTING							
Halogen headlights with Daytime Running Lights		●	—	—	—	—	
Bi-function Xenon headlights with LED 'J' blade Daytime Running Lights, automatic levelling and headlight power wash	064CW	○	●	●	●	●	
LED headlights with LED 'J' blade Daytime Running Lights, adaptive lighting, turning light, Automatic High Beam Assist and headlight power wash	064GJ	○	○	○	○	○	Refer to page 10
TOWING							
Detachable tow bar ¹	028EM	○	○	○	○	○	Tow bar is not available with 20" wheels if space saver spare is fitted on XF Sportbrake
Electrically deployable tow bar ^{1,2}	028EJ	○	○	○	○	○	Tow bar is not available with 20" wheels if space saver spare is fitted on XF Sportbrake
EXTERIOR COLOURS							(Please see pages 70-71 for full colour palette)
Solid paint		●	●	●	●	●	Refer to page 70
Metallic paint		○	○	○	○	○	Refer to page 70-71
Premium paint		○	○	○	○	○	Refer to page 71
WHEELS							(Availability of wheels is subject to choice of engine, please see pages 72-73 to see the full range)
Jaguar Tyre Repair System		●	●	●	●	●	
Space saver spare wheel (18")	029VT	○	○	○	○	○	Not available with 20" wheels if tow bar is fitted on XF Sportbrake
Tyre Pressure Monitoring System		●	●	●	●	●	

● Standard ○ Option — Not available ■ Part of Pack

¹Not available on 2.0 litre 4-cylinder 163PS Diesel engine on XF Saloon with manual transmission.

²Not available on 2.0 litre 4-cylinder 163PS Diesel engine on XF Sportbrake. Reduced towing limit on 2.0 litre 4-cylinder 163PS Diesel engine on XF Saloon.

³Only available in sports grained leather (033YF).

Please consult your local Jaguar Retailer for details.

For a complete list of optional features and packs refer to the XF Specification and Price Guide or configure your vehicle at jaguar.com

SEATING AND VENEERS

		PURE	PRESTIGE	PORTFOLIO	R-SPORT	S	
SEATING		CODE					DESCRIPTION
Heated front seats	033BV	○	○	○	○	○	
Heated front and rear seats	033EQ	—	○	○	○	○	
Climate front seats (requires leather seats and 4-way electric lumbar adjust)	033GP	—	○	○	○	○	Heated and cooled front seats
Climate front seats and heated rear seats (requires leather seats and 4-way electric lumbar adjust)	033GQ	—	○	○	○	○	Heated and cooled front and rear seats
8-way manual front seat with electric recline (standard on 2.0 litre 4-cylinder 163PS Diesel engine only)		●	—	—	—	—	
10-way electric front seats with manual headrest height (optional on 2.0 litre 4-cylinder 163PS Diesel engine only)	033UK	○/●	●	●	●	●	
4-way electric lumbar adjust (not available with 8-way seats)	033JT	○	○	○	○	○	
Driver memory		■	■	■	■	■	Adjusts driver seat, mirrors and steering column. Only available as part of Memory Pack without power fold mirrors and Memory Pack with power fold mirrors
18-way electric front sports seats		—	—	—	■ ³	■	With manual headrest height, 4-way electric lumbar adjust and passenger and driver memory. Only available as part of Premium Seat Upgrade with Memory Pack
20-way electric front luxury seats		—	—	■	—	—	With manual winged headrest height, 4-way electric lumbar adjust and passenger and driver memory. Only available as part of Premium Seat Upgrade with Memory Pack
Sports grained leather seats	033YF	—	—	—	○	○	
40:20:40 split fold rear seat with armrest (standard on all XF Sportbrake models)	033LP	○	○	○	○	○	

VENEERS

Please see pages 90-91 for full range of veneers

HEADLINING AND INTERIOR FEATURES

HEADLINING						
Light Oyster headlining	032FE	●	●	●	○	○
Ebony headlining	032BU	○	○	○	●	●
Suedecloth headlining		●	●	●	●	●
Morzine headlining	088HH	○	○	○	○	○

2 CHOOSE YOUR OPTIONS

 Configure your vehicle at jaguar.com

HEADLINING AND INTERIOR FEATURES CONTINUED

INTERIOR FEATURES	CODE	PURE	PRESTIGE	PORTFOLIO	R-SPORT	S	DESCRIPTION
Illuminated metal treadplates with Jaguar script		●	●	●	●	●	
Metal treadplates with R-SPORT branding	048BN	—	—	—	○	—	
Metal treadplates with S branding	048BP	—	—	—	—	○	
Premium carpet mats		●	●	●	●	●	
Bright metal pedals		●	●	●	●	●	
Soft grain leather steering wheel		●	—	—	—	—	
Soft grain leather sport steering wheel		—	●	●	—	—	
R-Sport branded soft grain leather steering wheel		—	—	—	●	—	
S branded soft grain leather steering wheel		—	—	—	—	●	
Heated steering wheel (requires heated front seats)	032DV	○	○	○	○	○	
Electrically adjustable steering column	049AP	○	○	○	○	○	
Cabin pre-conditioning with remote	043BH	○	○	○	○	○	
Four-zone Climate Control with two additional power sockets (requires air quality sensor and lockable cooled glove box) ¹	022BC	○	○	○	○	○	Refer to page 17
Air quality sensor and lockable cooled glove box	022FA, 030DH	○	○	○	○	○	
Cabin Air Ionisation (only available on XF Sportbrake)	022GB	○	○	○	○	○	Refer to page 15
Manual rear side window sunblinds	112RC	○	○	○	○	○	
Electric rear window sunblind (not available on XF Sportbrake)	019CA	○	○	○	○	○	
Powered gesture roof blind (only available on XF Sportbrake. Requires fixed panoramic roof. Not available if Dual View is fitted. Removes sunglasses holder if fitted)	188FB	○	○	○	○	○	Refer to page 21
Interior Lighting		●	—	—	—	—	
Ambient Interior lighting	064FB	○	●	●	●	●	
Configurable Ambient Interior Lighting with (10 colours)	064FC	○	○	○	○	○	Refer to page 17
Smoker's Pack	094AA	○	○	○	○	○	Includes single front ashtray, single cigar lighter and two single ashtray holders in rear door bins
Two additional power sockets	054AK	○	○	○	○	○	Additional 12V power socket in rear centre console and boot
Loadspace storage rails (only available on XF Sportbrake)	135AH	○	○	○	○	○	Refer to page 21

● Standard ○ Option — Not available

¹Not available on 2.0 litre 4-cylinder 163PS Diesel engine.

²HomeLink® is a registered trademark of Gentex Corporation.

Please consult your local Jaguar Retailer for details.

For a complete list of optional features and packs refer to the XF Specification and Price Guide or configure your vehicle at jaguar.com

SAFETY AND SECURITY

SAFETY AND SECURITY	CODE	PURE	PRESTIGE	PORTFOLIO	R-SPORT	S	DESCRIPTION
Front Parking Aid		●	●	●	●	●	
Rear Parking Aid		●	●	●	●	●	
Rear Camera		●	●	●	●	●	Refer to page 50
360° Surround Camera (requires power fold mirrors)	086GC	○	○	○	○	○	Refer to page 50
Park Assist	086HA	○	○	○	○	○	Refer to page 50
360° Parking Aid	036MB	○	○	○	○	○	Refer to page 50
Garage Door Opener (HomeLink®) ²	025CT	○	○	○	○	○	
Lane Keep Assist and Driver Condition Monitor		●	●	●	●	●	Refer to page 51
Blind Spot Monitor and Rear Traffic Detection (requires power fold mirrors)	086GF	○	○	○	○	○	Refer to page 51
Blind Spot Assist and Reverse Traffic Detection (requires power fold mirrors)	086GG	○	○	○	○	○	Refer to page 51
Traffic Sign Recognition and Adaptive Speed Limiter (requires Navigation Pro)	086DC	○	○	○	○	○	Refer to page 50
Keyless Entry	066AC	○	○	○	○	○	
Activity Key (only available with XF Sportbrake)	066CA	○	○	○	○	○	Refer to page 19

2 CHOOSE YOUR OPTIONS

 Configure your vehicle at jaguar.com

INCONTROL INFOTAINMENT AND CONNECTIVITY

INCONTROL INFOTAINMENT AND CONNECTIVITY	CODE	PURE	PRESTIGE	PORTFOLIO	R-SPORT	S	DESCRIPTION
10" Touch Pro		●	●	●	●	●	Refer to page 43
Analogue Dials with Central TFT Display		●	●	●	●	●	
Interactive Driver Display (requires Navigation Pro)	038ID	○	○	○	○	○	
Sound System		●	●	●	●	●	Refer to page 48-49
Meridian™ Sound System	025LM	○	○	○	○	○	Refer to page 48-49
Meridian™ Surround Sound System	025LN	○	○	○	○	○	Refer to page 48-49
10" Touch Pro Dual View (requires Navigation Pro, CD/DVD player and Meridian™ Sound System)	087AS	○	○	○	○	○	
Digital TV	129AA	○	○	○	○	○	
Navigation Pro (requires Connect Pro)	087AU	○	○	○	○	○	Refer to page 46-47
CD/DVD player (requires Navigation Pro)	025AM	○	○	○	○	○	
Protect		●	●	●	●	●	Includes SOS Emergency Call, Jaguar Optimised Assistance and Remote Essentials smartphone app. Refer to page 45
Smartphone Pack		●	●	●	●	●	Includes Android Auto™ and Apple CarPlay*. Refer to page 47
Secure Tracker	011AE	○	○	○	○	○	Stolen Vehicle Tracking via your smartphone app. Refer to page 47
InControl Apps	025PA	○	○	○	○	○	Refer to page 46
Digital Audio Broadcast (DAB) radio	025JB	○	○	○	○	○	

● Standard ○ Option — Not available

*Not available on 2.0 litre 4-cylinder 163PS Diesel engine.

Please consult your local Jaguar Retailer for details.

For a complete list of optional features and packs refer to the XF Specification and Price Guide or configure your vehicle at jaguar.com

OPTION PACKS

		PURE	PRESTIGE	PORTFOLIO	R-SPORT	S	
	CODE						DESCRIPTION
Cold Climate Pack	017CA	○	○	○	○	○	Consists of heated front windscreen, heated washer jets, heated steering wheel and heated front and rear seats (heated front seats only on Pure)
Power Convenience Pack	017DY	○	○	○	○	○	Consists of Keyless Entry, powered gesture boot lid and two additional power sockets
Advanced Park Assist Pack with 360° Surround Camera	017CQ	○	○	○	○	○	Consists of 360° Surround Camera, 360° Parking Aid and Park Assist
Black Pack	032EI	—	○	○	○	○	Consists of Gloss Black radiator grille and surround, side power vents, boot lid finisher, side window surround and body kit blades (except S. Includes Gloss Black roof rails on XF Sportbrake)
Memory Pack without power fold mirrors	017CJ	○	○	○	○	○	Consists of heated door mirrors with memory, electrically adjustable steering column, driver seat memory and 10-way electric front seats
Memory Pack with power fold mirrors	017CT	○	○	○	○	○	Consists of auto-dimming, power fold, heated door mirrors with memory and approach lights, electrically adjustable steering column, driver seat memory and 10-way electric front seats
Driver and Passenger Memory Pack with power fold mirrors	017GU	—	—	○	○	○	Consists of auto-dimming, power fold, heated door mirrors with memory and approach lights, electrically adjustable steering column, driver and passenger seat memory, 18-way electric front sport seats or 20-way electric front luxury seats
Rear Comfort Pack*	017FJ	○	○	○	○	○	Consists of heated front and rear seats (heated front seats only on Pure), Four-zone Climate Control, manual rear side window sunblinds, lockable cooled glove box, air quality sensing and electric rear window sunblind (Saloon only)
Sportbrake Convenience Pack (only available on XF Sportbrake)	017GL	○	○	○	○	○	Consists of powered gesture boot lid, Keyless Entry, Activity Key and loadspace storage rails
Head-up Display Pack	017FG	○	○	○	○	○	Consists of Head-up Display and Solar attenuating windscreen. Refer to page 43
Touch Pro Navigation Pack with Meridian Digital Sound System (requires Connect Pro Pack)	017EG	○	○	○	○	○	Consists of Navigation Pro, Meridian™ Sound System, Interactive Driver Display and CD/DVD Player. Refer to pages 42-47
Touch Pro Navigation Pack with Meridian Digital Surround Sound System (requires Connect Pro Pack)	017EI	○	○	○	○	○	Consists of Navigation Pro, Meridian™ Surround Sound System, Interactive Driver Display and CD/DVD Player. Refer to pages 42-47
Connect Pro Pack (requires Navigation Pro)	011CB	○	○	○	○	○	Consists of InControl Apps, Remote Premium and Pro Services and Wi-Fi Hotspot. Refer to page 46-47

3 CHOOSE YOUR COLOUR

 [Configure your vehicle at jaguar.com](https://www.jaguar.com)

SOLID

Fuji White

Narvik Black

METALLIC

Yulong White

Santorini Black

Indus Silver

Eiger Grey

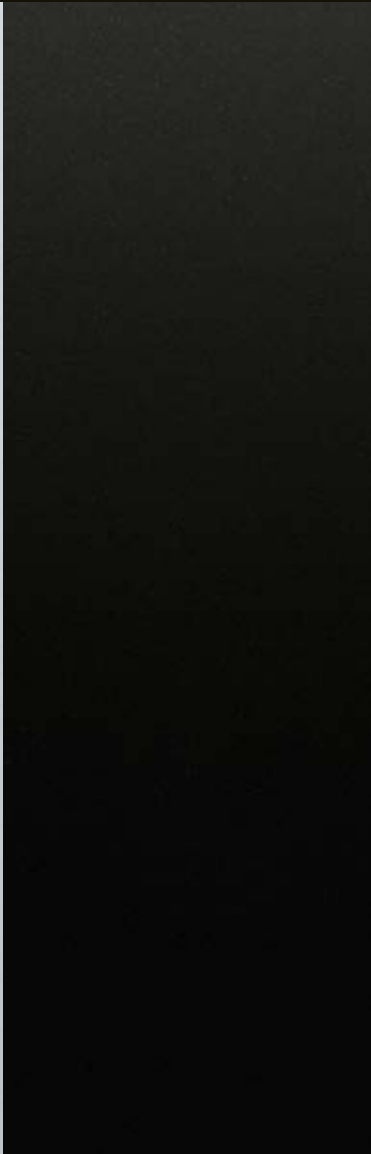
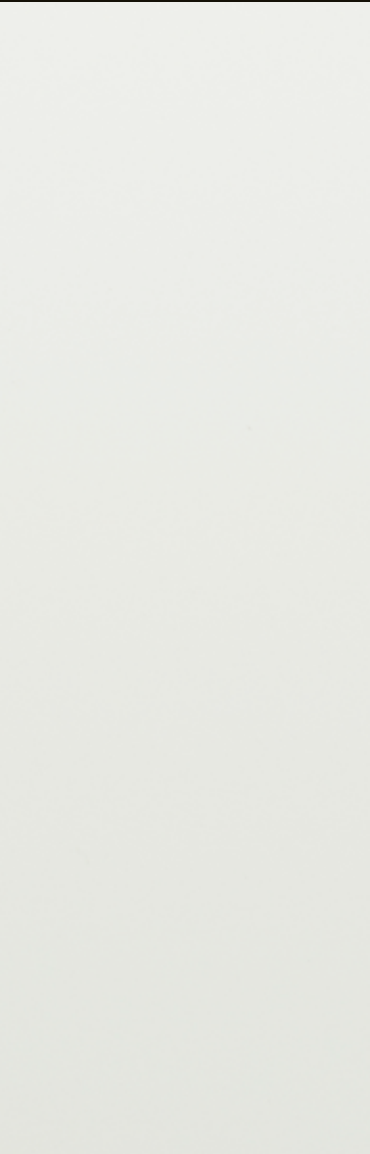

Portofino Blue



Caesium Blue



Firenze Red



Rossello Red



PREMIUM PALETTE

Carpathian Grey



Silicon Silver



4 CHOOSE YOUR WHEELS

 Configure your vehicle at jaguar.com



17" STYLE 1017,
10 SPOKE^{1,2}



17" STYLE 1016,
15 SPOKE³



17" STYLE 9005,
9 SPOKE³



18" STYLE 5034,
5 SPOKE⁷



18" STYLE 7011,
7 SPLIT-SPOKE⁷

ALLOY WHEEL FINISH	Gloss Sparkle Silver	Gloss Sparkle Silver	Gloss Sparkle Silver	Gloss Sparkle Silver	Gloss Sparkle Silver
ALLOY WHEEL/SIZE	7.5J x 17"	7.5J x 17"	7.5J x 17"	8.0J x 18"	8.0J x 18"
TYRE SIZE	225/55 R17	225/55 R17	225/55 R17	245/45 R18	245/45 R18
CODE	029WT	029WU	029WV	029WK	029WL

Pure	—	● ^{4,5}	○ ⁷ / ● ^{7,8}	○ ⁹	○
Prestige	○	● ^{4,5,6}	○ / ● ^{7,8}	○ ⁹	○
Portfolio	●	○ ^{2,5}	○ ^{1,2}	○	●
R-Sport	○	○ ^{2,5}	● ^{1,2}	○	○
S	—	—	—	—	—



18" STYLE 5033,
5 SPLIT-SPOKE⁷



18" STYLE 5033,
5 SPLIT-SPOKE⁷



18" STYLE 5033,
5 SPLIT-SPOKE⁷



19" STYLE 7012,
7 SPLIT-SPOKE⁷



19" STYLE 7013,
7 SPLIT-SPOKE⁷

ALLOY WHEEL FINISH	Gloss Sparkle Silver	Contrast/Diamond Turned	Gloss Black	Gloss Sparkle Silver	Gloss Sparkle Silver
ALLOY WHEEL/SIZE	8.0J x 18"	8.0J x 18"	8.0J x 18"	8.0J x 19"	8.0J x 19"
TYRE SIZE	245/45 R18	245/45 R18	245/45 R18	245/40 R19	245/40 R19
CODE	029WM	029WJ	029WH	029WN	029WO

Pure	○	○	○	○	○
Prestige	○	○	○	○	○
Portfolio	○	○	○	○	○
R-Sport	●	○	○	○	○
S	—	—	—	○	○

● Standard ○ Option — Not Applicable

¹Not available on XF Sportbrake. ²Only available with XF Saloon models with 2.0 litre 4-cylinder 163PS Diesel engine. ³Only available with 4-cylinder engines, excluding 300PS engines.

⁴Optional on XF Sportbrake with 180PS Diesel and 250PS Petrol engines. ⁵Standard on XF Sportbrake with 2.0 litre 4-cylinder 163PS Diesel engine. ⁶Optional on XF Sportbrake with 2.0 litre 4-cylinder 240PS AWD Diesel engine. ⁷Not available with 2.0 litre 4-cylinder 163PS Diesel engine. ⁸Standard on XF Sportbrake. ⁹Standard on 300PS engines.



19" STYLE 7013,
7 SPLIT-SPOKE⁷



19" STYLE 1018,
10 SPOKE⁷



19" STYLE 5035,
5 SPOKE⁷



19" STYLE 5035,
5 SPOKE⁷



20" STYLE 9004,
9 SPLIT-SPOKE⁷

ALLOY WHEEL FINISH	Contrast/Diamond Turned	Gloss Sparkle Silver	Gloss Dark Grey/Diamond Turned	Gloss Black	Gloss Silver
ALLOY WHEEL/SIZE	8.0J x 19"	8.0J x 19"	8.0J x 19"	8.0J x 19"	8.5J x 20"
TYRE SIZE	245/40 R19	245/40 R19	245/40 R19	245/40 R19	255/35 R20
CODE	029WS	029WP	029WR	029WQ	029WB
Pure	<input type="radio"/>	<input type="radio"/>	<input type="radio"/>	<input type="radio"/>	<input type="radio"/>
Prestige	<input type="radio"/>	<input type="radio"/>	<input type="radio"/>	<input type="radio"/>	<input type="radio"/>
Portfolio	<input type="radio"/>	<input type="radio"/>	<input type="radio"/>	<input type="radio"/>	<input type="radio"/>
R-Sport	<input type="radio"/>	<input type="radio"/>	<input type="radio"/>	<input type="radio"/>	<input type="radio"/>
S	<input type="radio"/>	<input type="radio"/>	<input checked="" type="radio"/>	<input type="radio"/>	<input type="radio"/>



20" STYLE 9004,
9 SPLIT-SPOKE⁷



20" STYLE 5071,
5 SPLIT-SPOKE⁷



20" STYLE 5031,
5 SPLIT-SPOKE⁷



20" STYLE 5031,
5 SPLIT-SPOKE⁷



20" STYLE 5036,
5 SPLIT-SPOKE⁷

ALLOY WHEEL FINISH	Contrast/Diamond Turned	Gloss Sparkle Silver	Gloss Dark Grey/Diamond Turned	Gloss Black	Gloss Dark Grey/Diamond Turned
ALLOY WHEEL/SIZE	8.5J x 20"	8.5J x 20"	8.5J x 20"	8.5J x 20"	8.5J x 20"
TYRE SIZE	255/35 R20	255/35 R20	255/35 R20	255/35 R20	255/35 R20
CODE	029WC	029WD	029VZ	029WE	029WA
Pure	<input type="radio"/>	<input type="radio"/>	<input type="radio"/>	<input type="radio"/>	<input type="radio"/>
Prestige	<input type="radio"/>	<input type="radio"/>	<input type="radio"/>	<input type="radio"/>	<input type="radio"/>
Portfolio	<input type="radio"/>	<input type="radio"/>	<input type="radio"/>	<input type="radio"/>	<input type="radio"/>
R-Sport	<input type="radio"/>	<input type="radio"/>	<input type="radio"/>	<input type="radio"/>	<input type="radio"/>
S	<input type="radio"/>	<input type="radio"/>	<input type="radio"/>	<input type="radio"/>	<input type="radio"/>

Standard and optional features may differ depending on market availability. On XF Sportbrake, when space saver wheel is fitted, 19" is the maximum wheel size permissible for the fitment of detachable tow bar O28EM and electrically deployable tow bar O28EJ.

5 CHOOSE YOUR INTERIOR

 Configure your vehicle at jaguar.com

PURE						
	SEAT WITH TONAL STITCH	UPPER FACIA WITH TONAL STITCH	INTERIOR TRIM AND OPTION CODES	HEADLINING SUEDECLOTH ¹	CARPET	VENEER
Standard						
Premium fabric seats (EU only)	Ebony with Ebony	Ebony with Ebony	TPZ	Light Oyster or Ebony ²	Ebony	Gloss Black
	Latte with Latte	Espresso with Espresso	TRA	Light Oyster	Espresso	Gloss Black
PRESTIGE						
	SEAT WITH TONAL STITCH	UPPER FACIA WITH TONAL STITCH	INTERIOR TRIM AND OPTION CODES	HEADLINING SUEDECLOTH ¹	CARPET	VENEER
Standard						
Grained leather seats	Ebony with Ebony	Ebony with Ebony	TRC	Light Oyster or Ebony ²	Ebony	Gloss Black
	Latte with Latte	Espresso with Espresso	TRD	Light Oyster	Espresso	Gloss Black
	Light Oyster with Light Oyster	Oyster with Oyster	TRE	Light Oyster	Oyster	Gloss Black
PORTFOLIO						
	SEAT WITH TONAL STITCH	UPPER FACIA WITH TONAL STITCH	INTERIOR TRIM AND OPTION CODES	HEADLINING SUEDECLOTH ¹	CARPET	VENEER
Standard						
Windsor leather seats	Ebony with Ebony	Ebony with Ebony	TRN	Light Oyster or Ebony ²	Ebony	Gloss Figured Ebony
	Latte with Latte	Espresso with Espresso	TRO	Light Oyster	Espresso	Gloss Figured Ebony
	Light Oyster with Light Oyster	Oyster with Oyster	TRP	Light Oyster	Oyster	Gloss Figured Ebony
	Espresso with Espresso	Espresso with Espresso	TRR	Light Oyster	Espresso	Gloss Figured Ebony
	Siena Tan with Siena Tan	Ebony with Ebony	TRQ	Light Oyster or Ebony ²	Ebony	Gloss Figured Ebony

¹Morzine headlining available as an option.

²Ebony headlining available as an option.

³Light Oyster headlining available as an option.

R-SPORT						
	DUO TONE SEAT WITH CONTRAST STITCH	UPPER FACIA WITH CONTRAST STITCH	INTERIOR TRIM AND OPTION CODES	HEADLINING SUEDECLOTH¹	CARPET	VENEER
Standard						
Sports grained leather seats with Technical Mesh inserts	Ebony/Ebony with Light Oyster	Ebony with Light Oyster	TRF	Ebony or Light Oyster ²	Ebony	Gloss Black
Option						
Grained leather sports seats	Ebony/Ebony with Light Oyster	Ebony with Light Oyster	TRF + 033YF	Ebony or Light Oyster ²	Ebony	Gloss Black
	Ebony/Pimento with Pimento	Ebony with Pimento	TRG + 033YF	Ebony or Light Oyster ²	Ebony	Gloss Black
	Ebony/Light Oyster with Light Oyster	Ebony with Light Oyster	TRH + 033YF	Ebony or Light Oyster ²	Ebony	Gloss Black
	Brogue/Brogue with Light Oyster	Ebony with Light Oyster	TRI + 033YF	Ebony or Light Oyster ²	Ebony	Gloss Black
S						
	DUO TONE SEAT WITH CONTRAST STITCH	UPPER FACIA WITH CONTRAST STITCH	INTERIOR TRIM AND OPTION CODES	HEADLINING SUEDECLOTH¹	CARPET	VENEER
Standard						
Sports grained leather seats with suedecloth inserts	Ebony/Ebony with Light Oyster	Ebony with Light Oyster	TRJ	Ebony or Light Oyster ²	Ebony	Grey Figured Ebony
	Pimento/Ebony with Ebony	Ebony with Pimento	TRK	Ebony or Light Oyster ²	Ebony	Grey Figured Ebony
Option						
Grained leather sports seats	Ebony/Ebony with Light Oyster	Ebony with Light Oyster	TRJ + 033YF	Ebony or Light Oyster ²	Ebony	Grey Figured Ebony
	Pimento/Ebony with Ebony	Ebony with Pimento	TRK + 033YF	Ebony or Light Oyster ²	Ebony	Grey Figured Ebony
	Light Oyster/Ebony with Ebony	Ebony with Light Oyster	TRL + 033YF	Ebony or Light Oyster ²	Ebony	Grey Figured Ebony
	Brogue/Brogue with Light Oyster	Ebony with Light Oyster	TRM + 033YF	Ebony or Light Oyster ²	Ebony	Grey Figured Ebony

5 CHOOSE YOUR INTERIOR

⚙️ Configure your vehicle at [jaguar.com](https://www.jaguar.com)













Interior shown: Ebony fabric seats with Ebony facia, Morse Code Aluminium finisher, Gloss Black veneer and optional Ebony headlining.



PURE

INTERIOR COLOUR COMBINATIONS

STANDARD

1	2	3	4	5	6
SEAT WITH TONAL STITCH	VENEER	HEADLINING SUEDECLOTH ¹	UPPER FACIA WITH TONAL STITCH	FINISHER	CARPETS
					
Ebony	Gloss Black	Light Oyster or Ebony ²	Ebony with Ebony	Morse Code Aluminium	Ebony
					
Latte	Gloss Black	Light Oyster	Espresso with Espresso	Morse Code Aluminium	Espresso

VENEER OPTIONS

Carbon Fibre Veneer, Satin Burr Ash Veneer, Gloss Figured Ebony Veneer, Grey Figured Ebony Veneer, Satin Fine Line Veneer, Satin Rosewood Veneer or Gloss Burr Walnut Veneer

¹Morzine headlining available as an option.

²Ebony headlining available as an option.

5 CHOOSE YOUR INTERIOR

⚙️ Configure your vehicle at [jaguar.com](https://www.jaguar.com)











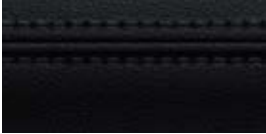





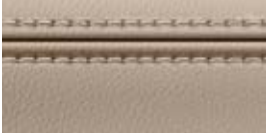

Interior shown: Ebony grained leather seats with Ebony tonal stitch, Ebony facia, Morse Code Aluminium finisher, Gloss Black veneer and optional Ebony headlining.



PRESTIGE

INTERIOR COLOUR COMBINATIONS

STANDARD

1	2	3	4	5	6
SEAT WITH TONAL STITCH	VENEER	HEADLINING SUEDECLOTH ¹	UPPER FACIA WITH TONAL STITCH	FINISHER	CARPETS
					
Ebony	Gloss Black	Light Oyster or Ebony ²	Ebony with Ebony	Morse Code Aluminium	Ebony
					
Latte with Latte	Gloss Black	Light Oyster	Espresso with Espresso	Morse Code Aluminium	Espresso
					
Light Oyster with Light Oyster	Gloss Black	Light Oyster	Oyster with Oyster	Morse Code Aluminium	Oyster

VENEER OPTIONS

Carbon Fibre Veneer, Satin Burr Ash Veneer, Gloss Figured Ebony Veneer, Grey Figured Ebony Veneer, Satin Fine Line Veneer, Satin Rosewood Veneer or Gloss Burr Walnut Veneer

¹Morzine headlining available as an option.

²Ebony headlining available as an option.

5 CHOOSE YOUR INTERIOR

Configure your vehicle at jaguar.com













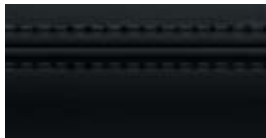

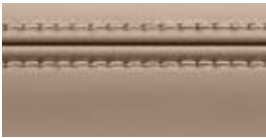



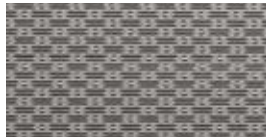



Interior shown: Latte Windsor leather seats with Latte tonal stitch, Espresso facia, Morse Code Aluminium finisher, Gloss Figured Ebony veneer and Light Oyster headlining.

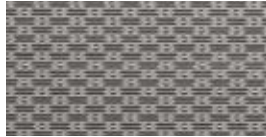
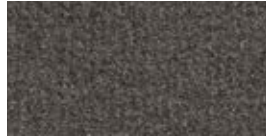
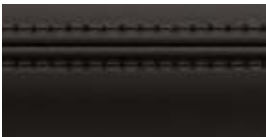

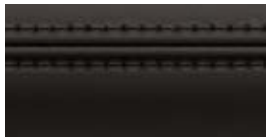
PORTFOLIO

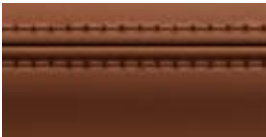
INTERIOR COLOUR COMBINATIONS

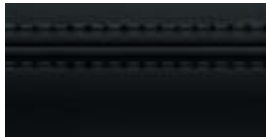
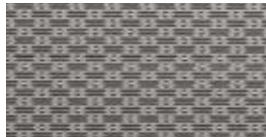
STANDARD

1	2	3	4	5	6
SEAT WITH TONAL STITCH	veneer	HEADLINING SUEDECLOTH ¹	UPPER FACIA WITH TONAL STITCH	FINISHER	CARPETS
					
Ebony with Ebony	Gloss Figured Ebony	Light Oyster or Ebony ²	Ebony with Ebony	Morse Code Aluminium	Ebony
					
Latte with Latte	Gloss Figured Ebony	Light Oyster	Espresso with Espresso	Morse Code Aluminium	Espresso
					
Light Oyster with Light Oyster	Gloss Figured Ebony	Light Oyster	Oyster with Oyster	Morse Code Aluminium	Oyster
					
Espresso with Espresso	Gloss Figured Ebony	Light Oyster	Espresso with Espresso	Morse Code Aluminium	Espresso
					
Siena Tan with Siena Tan	Gloss Figured Ebony	Light Oyster or Ebony ²	Ebony with Ebony	Morse Code Aluminium	Ebony

VENEER OPTIONS

Gloss Black Veneer, Carbon Fibre Veneer, Satin Burr Ash Veneer, Grey Figured Ebony Veneer, Satin Fine Line Veneer, Satin Rosewood Veneer or Gloss Burr Walnut Veneer

¹Morzine headlining available as an option.

²Ebony headlining available as an option.

5 CHOOSE YOUR INTERIOR

⚙️ Configure your vehicle at jaguar.com

Interior shown: Ebony grained leather sports seats with Ebony Technical Mesh inserts and Light Oyster contrast stitch, Ebony facia with Light Oyster contrast stitch, Dark Morse Code Aluminium finisher, Gloss Black veneer and optional Light Oyster headlining.



R-SPORT

INTERIOR COLOUR COMBINATIONS

STANDARD

1

DUO TONE SEAT WITH
CONTRAST STITCH

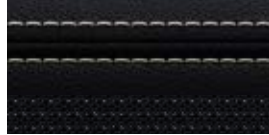

Ebony/Ebony with Light Oyster

2

VENEER

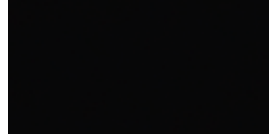

Gloss Black

3

HEADLINING SUEDECLOTH¹



Ebony or Light Oyster²

4

UPPER FACIA WITH
CONTRAST STITCH

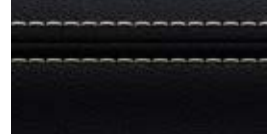

Ebony with Light Oyster

5

FINISHER



Dark Morse Code Aluminium

6

CARPETS



Ebony

VENEER OPTIONS

Carbon Fibre Veneer, Satin Burr Ash Veneer, Gloss Figured Ebony Veneer, Grey Figured Ebony Veneer, Satin Fine Line Veneer, Satin Rosewood Veneer or Gloss Burr Walnut Veneer

¹Morzine headlining available as an option.

²Light Oyster headlining available as an option.

5 CHOOSE YOUR INTERIOR

⚙️ Configure your vehicle at [jaguar.com](https://www.jaguar.com)











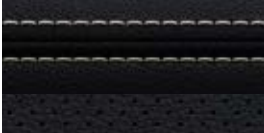

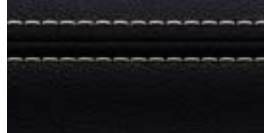

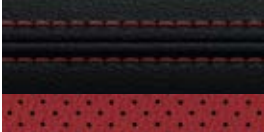

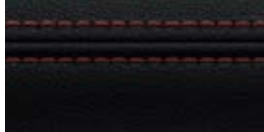



Interior shown: Ebony and Light Oyster perforated grained leather sports seats with Light Oyster contrast stitch, Ebony facia with Light Oyster contrast stitch, Dark Morse Code Aluminium finisher, optional Satin Fine Line veneer and optional Light Oyster headlining.

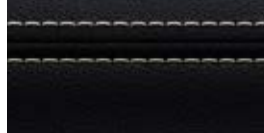

R-SPORT

INTERIOR COLOUR COMBINATIONS

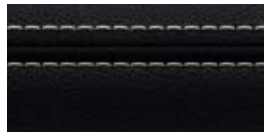
OPTION

1	2	3	4	5	6
<p>DUO TONE SEAT WITH CONTRAST STITCH</p>  <p>Ebony/Ebony with Light Oyster</p>	<p>VENEER</p>  <p>Gloss Black</p>	<p>HEADLINING SUEDECLOTH¹</p>  <p>Ebony or Light Oyster²</p>	<p>UPPER FACIA WITH CONTRAST STITCH</p>  <p>Ebony with Light Oyster</p>	<p>FINISHER</p>  <p>Dark Morse Code Aluminium</p>	<p>CARPETS</p>  <p>Ebony</p>
 <p>Ebony/Pimento with Pimento</p>	 <p>Gloss Black</p>	 <p>Ebony or Light Oyster²</p>	 <p>Ebony with Pimento</p>	 <p>Dark Morse Code Aluminium</p>	 <p>Ebony</p>
 <p>Ebony/Light Oyster with Light Oyster</p>	 <p>Gloss Black</p>	 <p>Ebony or Light Oyster²</p>	 <p>Ebony with Light Oyster</p>	 <p>Dark Morse Code Aluminium</p>	 <p>Ebony</p>
 <p>Brogue/Brogue with Light Oyster</p>	 <p>Gloss Black</p>	 <p>Ebony or Light Oyster²</p>	 <p>Ebony with Light Oyster</p>	 <p>Dark Morse Code Aluminium</p>	 <p>Ebony</p>

VENEER OPTIONS

Carbon Fibre Veneer, Satin Burr Ash Veneer, Gloss Figured Ebony Veneer, Grey Figured Ebony Veneer, Satin Fine Line Veneer, Satin Rosewood Veneer or Gloss Burr Walnut Veneer

¹Morzine headlining available as an option.

²Light Oyster headlining available as an option.

5 CHOOSE YOUR INTERIOR

⚙️ Configure your vehicle at [jaguar.com](https://www.jaguar.com)









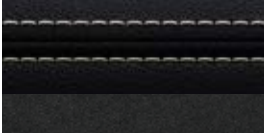

Interior shown: Ebony grained leather sports seats with Ebony suedecloth inserts and Light Oyster contrast stitch, Ebony facia with Light Oyster contrast stitch, Dark Hex Aluminium finisher, Grey Figured Ebony veneer and Ebony headlining.

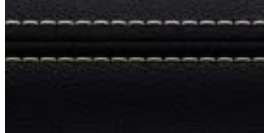

S

INTERIOR COLOUR COMBINATIONS

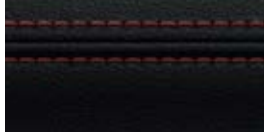
STANDARD

1	2	3	4	5	6
<p>DUO TONE SEAT WITH CONTRAST STITCH</p>  <p>Ebony/Ebony with Light Oyster</p>	<p>VENEER</p>  <p>Grey Figured Ebony</p>	<p>HEADLINING SUEDECLOTH¹</p>  <p>Ebony or Light Oyster²</p>	<p>UPPER FACIA WITH CONTRAST STITCH</p>  <p>Ebony with Light Oyster</p>	<p>FINISHER</p>  <p>Dark Hex Aluminium</p>	<p>CARPETS</p>  <p>Ebony</p>
<p>Pimento/Ebony with Ebony</p>  <p>Pimento/Ebony with Ebony</p>	<p>Grey Figured Ebony</p>  <p>Grey Figured Ebony</p>	<p>Ebony or Light Oyster²</p>  <p>Ebony or Light Oyster²</p>	<p>Ebony with Pimento</p>  <p>Ebony with Pimento</p>	<p>Dark Hex Aluminium</p>  <p>Dark Hex Aluminium</p>	<p>Ebony</p>  <p>Ebony</p>

VENEER OPTIONS

Gloss Black Veneer, Carbon Fibre Veneer, Satin Burr Ash Veneer, Gloss Figured Ebony Veneer, Satin Fine Line Veneer, Satin Rosewood Veneer or Gloss Burr Walnut Veneer

¹Morzine headlining available as an option.

²Light Oyster headlining available as an option.

5 CHOOSE YOUR INTERIOR

⚙️ Configure your vehicle at [jaguar.com](https://www.jaguar.com)













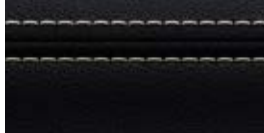





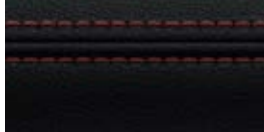



Interior shown: Light Oyster and Ebony perforated grained leather sports seats with Ebony contrast stitch, Ebony facia with Light Oyster contrast stitch, Dark Hex Aluminium finisher, Grey Figured Ebony veneer and Ebony headlining.

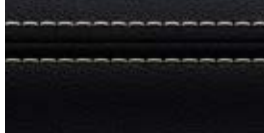

S

INTERIOR COLOUR COMBINATIONS

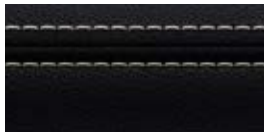
OPTION

1	2	3	4	5	6
<p>DUO TONE SEAT WITH CONTRAST STITCH</p>  <p>Ebony/Ebony with Light Oyster</p>	<p>VENEER</p>  <p>Grey Figured Ebony</p>	<p>HEADLINING SUEDECLOTH¹</p>  <p>Ebony or Light Oyster²</p>	<p>UPPER FACIA WITH CONTRAST STITCH</p>  <p>Ebony with Light Oyster</p>	<p>FINISHER</p>  <p>Dark Hex Aluminium</p>	<p>CARPETS</p>  <p>Ebony</p>
 <p>Pimento/Ebony with Ebony</p>	 <p>Grey Figured Ebony</p>	 <p>Ebony or Light Oyster²</p>	 <p>Ebony with Pimento</p>	 <p>Dark Hex Aluminium</p>	 <p>Ebony</p>
 <p>Light Oyster/Ebony with Ebony</p>	 <p>Grey Figured Ebony</p>	 <p>Ebony or Light Oyster²</p>	 <p>Ebony with Light Oyster</p>	 <p>Dark Hex Aluminium</p>	 <p>Ebony</p>
 <p>Brogue/Brogue with Light Oyster</p>	 <p>Grey Figured Ebony</p>	 <p>Ebony or Light Oyster²</p>	 <p>Ebony with Light Oyster</p>	 <p>Dark Hex Aluminium</p>	 <p>Ebony</p>

VENEER OPTIONS

Gloss Black Veneer, Carbon Fibre Veneer, Satin Burr Ash Veneer, Gloss Figured Ebony Veneer, Satin Fine Line Veneer, Satin Rosewood Veneer or Gloss Burr Walnut Veneer

¹Morzine headlining available as an option.

²Light Oyster headlining available as an option.

5 CHOOSE YOUR INTERIOR

 Configure your vehicle at jaguar.com

Gloss Black Veneer

Carbon Fibre Veneer

Satin Burr Ash Veneer

Gloss Figured Ebony Veneer



Grey Figured Ebony Veneer



Satin Fine Line Veneer



Satin Rosewood Veneer



Gloss Burr Walnut Veneer

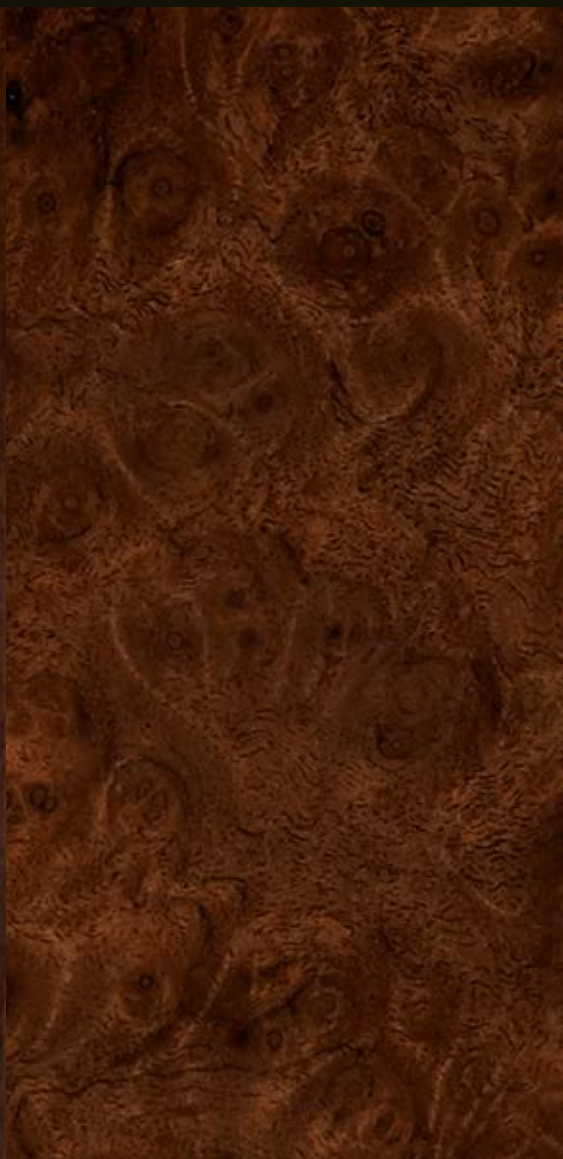

6 CHOOSE YOUR JAGUAR GEAR - ACCESSORIES

 Configure your vehicle at [jaguar.com](https://www.jaguar.com)

The genuine range of accessories from Jaguar.



Water Sports Carrier¹ **C2Z21730**

A versatile system for transporting a variety of water sports equipment including surfboard, kayak or sailboard. Tilts to facilitate loading/unloading.

¹Requires roof cross bars T2H14468. ²Not available for Pure.

VEHICLE SHOWN: XF SALOON S IN YULONG WHITE WITH OPTIONAL FEATURES FITTED (MARKET DEPENDENT)



Aluminium Paddle Shifters
T2R6547 Automatic transmission only
T2R6547CAY Red. Automatic transmission only

Replacement steering wheel gearshift paddles offered in a premium aluminium material providing a high quality finish to a key contact point in the vehicle. Manufactured from billet machined aluminium, the paddles are hand brushed for a premium finish and anodised to ensure they will not deteriorate with wear.



Premium Carpet Mats
T2H7171PVJ - LHD
T2H7173 - LHD AWD

Luxurious, tailored 2,050g/m² pile front carpet mats with embossed Jaguar logo and Nubuck edge binding. The premium mats provide a well appointed finishing touch to the interior.



Central Armrest Chiller/Warmer
T2H7739

Food and drinks chiller and warmer that acts as a rear centre armrest. With a leather-covered top, it is held in place by the centre seat belt and powered from the rear auxiliary socket. Ideal for long journeys with the family.



Click and Play - iPad Mini
J9C2165

The Click and Play iPad Mini holder is part of the Click and Go range. This removable tablet holder attachment can easily be positioned at multiple angles for in-cabin comfort and rear entertainment.



Personalised Illuminated Sill Treadplates²
T2H17122PVJ

Elegantly styled stainless steel sill treadplate finishers for driver or passenger doors. Illuminates when either the driver or passenger doors are opened. Highlighted by soft Phosphor Blue lighting. Allows you to specify a monochrome 'motif' in a choice of approved typefaces/scripts.



Rubber Mats
T4N7742 - LHD
T2H7743 - LHD AWD

Hard wearing Jaguar branded rubber mats provide added protection for your vehicle's carpets.

6 CHOOSE YOUR JAGUAR GEAR - ACCESSORIES

 Configure your vehicle at jaguar.com



Gloss Black Side Vent¹
T2H19534 - Left Side
T2H19531 - Right Side

Jaguar branded, Gloss Black side power vents provide a dynamic exterior styling enhancement.



Carbon Fibre Side Vent
T2H18318 - Left Side
T2H18319 - Right Side

High grade Carbon Fibre side power vents provide a performance-inspired styling upgrade.



Rear Tailgate Trim - Gloss Black²
T2H17748

Add style and visual distinction with Gloss Black finish rear tailgate trim.



Gloss Black Mirror Cap
C2D6067PEC - Left Side
C2D6066PEC - Right Side

Gloss Black mirror covers accentuate the dynamic design of the exterior mirrors.



Carbon Fibre Mirror Cap
C2P24176 - Right Side
C2P24177 - Left Side

High grade Carbon Fibre mirror covers provide a performance-inspired styling upgrade.



Splash Guards
T2H12952 - Front
T2H12953 - Front (R-Sport & S)
T2H12954 - Rear

Jaguar branded splash guards complement the lines of your vehicle, reduce spray and provide protection from dirt and stone chippings.

¹Not applicable for R-Sport. ²Only available on XF Saloon. ³Requires roof cross bars T2H14468.



Roof Cross Bars²
T2H14468

Jaguar branded cross bars required for fitting all roof carrying equipment. Engineered specifically for your vehicle.



Ski/Snowboard Holder³
C2A1538

A safe and secure Jaguar branded system for transporting winter sports equipment. Incorporates slider rails for easy loading. For four pairs of skis or two snowboards.



Roof Luggage Box³
C2C41628

Spacious 410 litre capacity lockable roof luggage box, measuring 175 x 82 x 45cm.



Wheel Mounted Roof Cycle Carrier³
C2A1539

An easy to fit, roof mounted, lockable cycle carrier which carries one bike per holder. A maximum of three holders can be fitted. Maximum cycle weight 20kg per carrier.



Fork Mounted Cycle Carrier³
C2A1540

Fitted to the roof, the fork mounted cycle carrier provides a simple and secure fitting with the bike front wheel removed, ideally suited to lightweight bikes and 'racing' wheels. A separate carrier is included for the front wheel. Easy to fit, lockable cycle carrier which carries one bike per holder. A maximum of three holders can be fitted.



Tow Bar Mounted Cycle Carrier
C2Z22695 - 2 Bike
C2Z22697 - 3 Bike

Premium tow ball mounted cycle carriers provide a convenient bike carrying solution with quick release loading attachments and secure locking mechanism. Clever design allows carrier to be tilted away from vehicle when fitted allowing access into the rear tailgate.

6 CHOOSE YOUR JAGUAR GEAR - ACCESSORIES

 Configure your vehicle at [jaguar.com](https://www.jaguar.com)

The genuine range of accessories from Jaguar.



Wheel Mounted Roof Cycle Carrier¹ C2A1539

An easy to fit, roof mounted, lockable cycle carrier which carries one bike per holder. A maximum of three holders can be fitted.

¹Requires roof cross bars T2H24300. ²Only available on XF Sportbrake.

VEHICLE SHOWN: XF SPORTBRAKE S IN YULONG WHITE WITH OPTIONAL FEATURES FITTED (MARKET DEPENDENT)



Roof Cross Bar²
T2H24300

Jaguar branded cross bars required for fitting all roof carrying equipment. Engineered specifically for your vehicle.



Roof Luggage Box¹
C2C41628

Spacious 410 litre capacity lockable roof luggage box, measuring 175 x 82 x 45cm. Maximum load capacity of accessory is 75kg.



Fork Mounted Cycle Carrier¹
C2A1540

Fitted to the roof, the fork mounted cycle carrier provides a simple and secure fitting with the bike front wheel removed, ideally suited to lightweight bikes and 'racing' wheels. A separate carrier is included for the front wheel. Easy to fit, lockable cycle carrier which carries one bike per holder. A maximum of three holders can be fitted.



Water Sports Carrier¹
C2Z21730

A versatile system for transporting a variety of water sports equipment including surfboard, kayak or sailboard. Tilts to facilitate loading/unloading.



Ski/Snowboard Holder¹
C2A1538

A safe and secure Jaguar branded system for transporting winter sports equipment. Incorporates slider rails for easy loading. For four pairs of skis or two snowboards.



Tow Bar Mounted Cycle Carrier
C2Z22695 - 2 Bike
C2Z22697 - 3 Bike

Premium tow ball mounted cycle carriers provide a convenient bike carrying solution with quick release loading attachments and secure locking mechanism. Clever design allows carrier to be tilted away from vehicle when fitted allowing access into the rear tailgate.

6 CHOOSE YOUR JAGUAR GEAR - ACCESSORIES

 Configure your vehicle at jaguar.com



Click and Play - iPad[®] 2-4
J9C2163

Click and Play is a removable tablet holder attachment which is available for various tablets, and can be easily positioned in multiple angles for in cabin comfort and rear entertainment.



Click and Hook
J9C2169

Click and Hook is a universal hook that creates extra storage space for items to be hung.



Click and Hang
J9C2167

Click and Hang is a removable coat hanger allowing for shirts and jackets to be kept crease-free whilst transporting.



Union Jack Sill Treadplates
T2H17123PVJ - Ebony
T2H17123AMT - Oyster

Elegantly styled stainless steel sill treadplate finisher for driver or passenger doors featuring a distinctly British design.



Sport Pedal Covers
T2H3747 - Manual
T2H3746 - Automatic (not shown)

Made from stainless steel and rubber, the pedal kit fits securely over existing pedals for a contemporary, sporting appearance. Standard on 'S'.



Luggage Compartment Waterproof Liner¹
T2H24704

Total protection for the luggage compartment and second row seat back. Bespoke developed for XF Sportbrake, the liner is a fully waterproof and is easy to fit or remove in a matter of minutes.

¹Only available on XF Sportbrake. ²Can also be fitted with either Rubber Liner (T2H25062) or Rubber Mat (T2H24552).



**Aperture Retention Net¹
T2H31242**

The aperture retention net prevents small items from falling out of the loadspace when the tailgate is opened and maximises packing space. Manufactured from premium lightweight materials including high grade machined aluminium to ensure robust quality.



**Luggage Compartment Collapsible Organiser
T2H7752**

Collapsible luggage compartment organiser keeps items from shifting during transport with two durable straps.



**Pet Access Ramp T2H38744
Portable Rinse System T2H38746
Foldable Pet Carrier T2H38745
Spill Resistant Water Bowl T2H38743
Quilted Loadspace Liner² T2H40499**

Taking the effort out of transporting pets, this option ensures everything required is to hand to transport pets in comfort. Combines the full height luggage partition, quilted loadspace liner, pet access ramp and portable rinse system.



**Luggage Compartment Rubber Mat¹
T2H24552**

This premium mat is tailored specifically to protect the luggage compartment. Light and durable, it is easily removable for cleaning.



**Luggage Compartment Multi-purpose Liner¹
T2H24651**

All-in-one premium loadspace carpet mat and double layer reversible rubber liner helps protect the rear loadspace area from general dirt. The liner can be folded out to cover the back of the second row seats when folded down. Also includes fold out bumper protector.



**Bumper Protector¹
T2H24701**

Provides protection for the rear bumper from scuffs and scratches and helps to prevent clothing from collecting dirt when loading and unloading.

SPECIAL VEHICLE OPERATIONS



Special Vehicle Operations (SVO) designs and engineers products that amplify Jaguar and Land Rover core brand values; focusing on luxury, performance and capability.

Our team of specialists is completely focused on enhancing and personalising our relationship with our most discerning and enthusiastic customers – delivering experiences that our customers will love for life.

SVO is responsible for the creation of a suite of halo products that showcase the pinnacle of Jaguar design and engineering capabilities, enabling our customers to indulge their passion for spectacular new vehicles.

THE NEW SVO TECHNICAL CENTRE

In the heart of the British Midlands is SVO's brand new Technical Centre. This state-of-the-art facility represents a £20m investment by Jaguar Land Rover, and features four zones designed to support the creation of truly breath-taking vehicles. In addition to the Commissioning and Presentation suites, our manufacturing centre is responsible for the assembly and hand-finishing of SVO halo and Collector's Edition vehicles, and a world-class paint facility ensures an exquisite finish for every car we create.

BESPOKE BY SVO

Bespoke by SVO was born out of an innate understanding of what our most discerning clients value more than anything else – to own something completely unique to them. Something only they can have, reflecting who they are and what they hold most dear. With that in mind, SVO developed innovative Commissioning and Presentation suites enabling creation of the most refined and luxurious vehicles in the world. This special new facility is housed within the new SVO Technical Centre in Warwickshire, England.





THE WORLD OF JAGUAR

Your Jaguar drives with an instinct for performance, refined through decades of innovative design and engineering. Power and agility are combined with elegance and grace to deliver a vehicle like no other. As a celebration of Jaguar, we've created a range of experiences, publications and the Jaguar Lifestyle Collection. To top it all, we've even returned to the track with Jaguar Racing. Welcome to a world where every aspect of performance is an art.

EXPERIENCE DRIVES



There's no better way of understanding the spirit of Jaguar than by getting behind the wheel. Jaguar Experience Drives are an opportunity to unleash the breathtaking performance of our incredible Jaguar range. Join us at one of our Experience centres, or take part in the Art of Performance Tour. New sensations await.

[jaguar.com/experience](https://www.jaguar.com/experience)

JAGUAR LAND ROVER ICE ACADEMY



Take your driving to the next level with Jaguar Land Rover Ice Academy. Located on one of the many frozen lakes in Arjeplog, Sweden, your driving skills will be tested through tackling some of the harshest, most challenging tracks on the planet. It's a rare chance to dance on ice and glide around awe-inspiring corners, all under the expert guidance of our instructors. Encounter the true exhilarating potential of the latest Jaguar and Land Rover vehicles in extreme conditions.

[jaguar.com/ice-academy](https://www.jaguar.com/ice-academy)

Follow us on:



MANUFACTURING TOURS

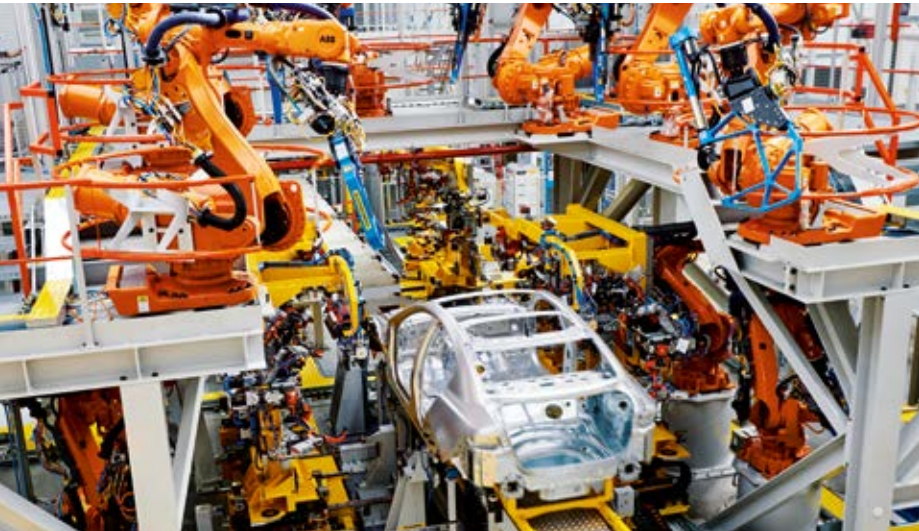

Witness at first-hand a Jaguar being brought to life. Behind our award-winning craftsmanship lies an unrivalled harmony of skilled technicians and cybernetic production robots. Our expert tour guides will accompany you as you make your way through the hi-tech manufacturing process, from sheet metal to the finished creation.

jaguar.com/tours

SPECIAL VEHICLE OPERATIONS



With outstanding performance, cutting-edge technology and incomparable luxury, Jaguar is a showcase for the finest in design and engineering. Special Vehicle Operations takes this even further. Adorned with the SV badge, halo models and limited-run collector's editions are the very pinnacle of the Jaguar range, offering a combination of the ultimate in power and dynamics.

jaguar.com/svo

ABB FIA FORMULA E

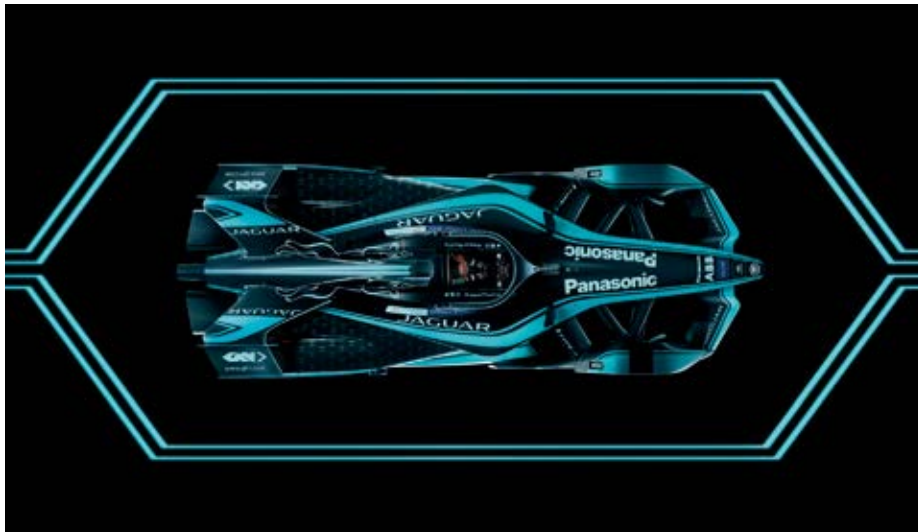

Jaguar's reputation for performance, technology and design was forged at the world's most challenging circuits and championships. From Le Mans to Formula 1, and now Formula E, the grid is our test bed. Formula E provides the perfect proving ground for electric vehicle technology in a high performance environment. The racing series accelerates the development of Jaguar's electric powertrains. With every race, Formula E helps Jaguar engineers to create better electric vehicles.

jaguar.com/jaguar-racing

JAGUAR I-PACE eTROPHY



We're making history. Again. Our latest development as leader in the global automotive race to electrification is I-PACE eTrophy - the world's first all-electric production-based international race series. Engineered and built by Special Vehicle Operations to compete on the zero emissions world stage; racers of the future will push electrification to thrilling heights.

jaguar.com/etrophy

Follow us on:



THE JAGUAR LIFESTYLE COLLECTION



Our latest range of apparel and lifestyle accessories is inspired by Jaguar's rich heritage, racing expertise, and iconic designs. This exclusive, impressively executed collection follows the performance-orientated style that is Jaguar.

jaguar.com/collection

THE JAGUAR MAGAZINE



This is our own vibrant, cosmopolitan and contemporary magazine. Go behind the scenes at Jaguar and explore our dedication to performance, design and innovation – as well as catching an insight into the world of luxury, style and travel. You can enjoy The Jaguar magazine twice a year, completely free of charge for the first three years of ownership. Ask your local Jaguar Retailer to ensure that you receive your copy.

jaguar.com/magazine



AT YOUR SERVICE

As well as providing a range of exclusive services and lifestyle products, the World of Jaguar makes owning and driving carefree and easy.

JAGUAR CARE*

XF is offered with a three year or 100,000km warranty and three years standard servicing programme. We call this programme Jaguar Care. It makes XF's overall cost of ownership one of the lowest in its class. To find out more about XF's Jaguar Care programme, please go to jaguar.com/jaguarcare

GENUINE PARTS

Jaguar Genuine Parts are designed, tested and manufactured to our uncompromising standards for quality, fit and durability. Each part is engineered specifically for your XF to contribute to optimum performance and to help maximise its lifespan.

FLEET & BUSINESS

Jaguars are dynamic and distinctive cars that help companies express the unique character and personality of their business. We are committed to providing customer-focused aftersales services, ensuring that every Jaguar performs to the highest standard and in the most cost-efficient way for businesses. Visit jaguar.com/fleet-and-business for more information.

JAGUAR ASSISTANCE

Jaguar Assistance provides assistance in motoring emergencies, from immobilisation due to breakdown or accident to minor problems such as punctures. You can rely on our roadside assistance, whatever the situation, wherever you happen to be.

JAGUAR FINANCIAL SERVICES

New or used, for personal or business use, we have a finance option that puts you in complete control. Please speak to your local Jaguar Retailer to find out more.

INSURANCE

XF's key components are easily accessible for time-efficient service and repair costs. With a focus on lower repair costs, XF delivers competitive insurance group ratings. To find out more about the compelling business case for XF, please contact your local Jaguar Retailer.

IMPORTANT NOTICE

Jaguar Land Rover Limited is constantly seeking ways to improve the specification, design and production of its vehicles, parts and accessories and alterations take place continually. Whilst every effort is made to produce up to date literature, this brochure should not be regarded as an infallible guide to current specifications or availability, nor does it constitute an offer for the sale of any particular vehicle, part or accessory. Distributors and retailers are not agents of Jaguar Land Rover Limited by any express or implied undertaking or representation.

COLOURS

The colours reproduced here are subject to the limitations of the printing process and may therefore vary slightly from the actual vehicle. The company reserves the right to alter or withdraw any colour finish without notice. Some of these colours may not be obtainable in your country. Please check availability of colours and current specifications with your Jaguar Retailer. Distributors and retailers are not agents of Jaguar Land Rover Limited and have absolutely no authority to bind Jaguar Land Rover Limited to any express or implied undertaking or representation.

ENVIRONMENTAL INNOVATION AT JAGUAR

Jaguar is committed to reducing dependency on fossil fuels, using fewer natural resources and creating less waste as part of our approach to responsible and sustainable business development.

Search 'Jaguar Environmental Innovation' for more details.

*Selected European Markets only.

Castrol EDGE Professional exclusively recommended by Jaguar.

Meridian is the registered trademark of Meridian Audio Ltd. Meridian™ is a registered trademark of Meridian Audio Ltd. Trifield and the 'three fields' device is a trademark of Trifield Productions Ltd.

The Bluetooth® word mark and logos are owned by the Bluetooth SIG, Inc. and any use of such marks by Jaguar Land Rover Limited is under license. iPhone is a trademark of Apple Inc., registered in the US and other countries. The navigation system must always be used in conditions that will not affect the driver's ability to drive safely or affect the safety of other road users. HomeLink® is a registered trademark of Gentex Corporation.

VEHICLES SHOWN FRONT AND BACK COVER: XF SPORTBRAKE S IN YULONG WHITE AND XF SALOON IN EIGER GREY WITH OPTIONAL FEATURES FITTED (MARKET DEPENDENT)

VEHICLE SHOWN LEFT: XF SPORTBRAKE R-SPORT IN EIGER GREY WITH OPTIONAL FEATURES FITTED (MARKET DEPENDENT)

Jaguar Land Rover Limited
Registered Office: Abbey Road, Whitley,
Coventry, CV3 4LF, United Kingdom

Registered in England Number: 1672070

jaguar.com

© Copyright Jaguar Land Rover Limited 2019

1X2602010000BXXEN01P

