

THE M8

GRAN COUPÉ



BAYERISCHE MOTOREN WERKE



01

THE FIRST BMW M8 GRAN COUPÉ



02

DESIGN AND HIGHLIGHTS

- 22 The Vision
- 24 Design BMW M8 Gran Coupé
- 28 Editorial "The sound must be unique."
- 30 M philosophy
- 32 Editorial "The Unconventional Thinker."

03

INNOVATION AND TECHNOLOGY

- 34 The Vision
- 36 Driver assistance
- 38 Connectivity and infotainment
- 40 Comfort and functionality



04

EQUIPMENT

- 42 The Vision
- 44 Models
- 48 BMW Individual
- 50 Exterior Colours
- 52 Interior Colours
- 54 Technical data



YOUR NEW SPEED DATING APP.

Download now the BMW Brochures app from your app store and discover driving pleasure!



Let's talk about courage,
and why we need it more than ever.

Courage is independent and disruptive.
Courage questions, shatters and awakens.

We need bold, courageous voices.
All of us.
We need fresh thinkers with optimism.

We believe in the frontrunners.
The avantgarde, those who fight stagnation
and backwardness.

Courage only knows moving forward.
Driving the pioneers of our culture
to inspire tomorrow.
To create a sublime kind of new.
Reaching a superior level of excellence.

This is where a
new kind of luxury is born.



BAYERISCHE MOTOREN WERKE

CHARACTER.

DO LOOKS SHAPE PERSONALITY,
OR IS IT THE OTHER WAY AROUND?
EVERYTHING CHANGES WHEN
PERSONALITY AND LOOKS
COMBINE IN AN EXCEPTIONAL WAY.





384.000

KILOMETRES DOES LIGHT TRAVEL
TO REACH FROM THE MOON TO
THE EARTH.
NEVER HAS A ROUTE BEEN SO
WORTHWHILE.





The image shows the interior of a BMW M Competition car at night. The car is parked in a desert-like landscape under a starry sky. The interior is illuminated with ambient lighting, primarily in shades of red and orange. The steering wheel features the BMW logo and M Competition branding. The dashboard and center console are visible, with the M Competition logo prominently displayed on the center console. The seats are upholstered in a light-colored material with a dark pattern. The overall atmosphere is one of luxury and performance.

MOVEMENT

TAKES US FROM ONE PLACE
TO ANOTHER AND FROM TODAY
TO TOMORROW.

BUT IF WE REALLY WANT TO
MOVE SOMETHING,
WE HAVE TO MOVE ONE THING
ABOVE ALL ELSE: OURSELVES.





THE FOCUS

IS ON LOOKING AHEAD.
THE PAST IS OVER.
WHAT COUNTS IS THIS MOMENT.
MILE AFTER MILE.





AT THE TOP

IT IS NOT AS LONELY
AS IT SEEMS.
IN THE END,
ALL EYES REST
ON THOSE WHO REACH IT.

02

WE DESIGNERS LOVE EXTREMES.

He is passionate about it – you can tell by the conversation. Domagoj Dukec, BMW chief designer, designs vehicles with passion. The design of the BMW M8 emphasises in every detail that this is a true sports car. A dream car.

The BMW M8 has what it takes to become an icon thanks to its unmistakable profile. Is there some kind of credo for the M vehicles?

They don't say M is the strongest letter in the world for nothing. M was the first sub-brand to bring motorsport into mass production. Over the decades, individual M design features have developed into unique icons. They are all based on the technical requirements of the high-performance models and make those requirements visible in the design.

What design features are involved?

In the BMW M8, for example, we have a distinct three-hole division of the air intake. These are not fake air intakes, they actually have a function. The M8 also has an M specific kidney grille with double slats, exterior mirrors with aerodynamic additional wings, lightweight Double-spoke style wheels and much more. It is not only important that the vehicle delivers high

performance, but also that it looks like it. The double-flow exhaust system, for example, is particularly striking at the rear. The M8 is very successful in the GTE racing series. We directly proved that our top model is also at home in motorsport.

M PUSHES THE CONTROLLER IN THE DIRECTION OF RADICALITY.

The M8 has a very sensual shape. How did this idea actually come about?

In recent years, I have also been responsible for the design of the BMW 8 Series production model. That was a huge potential, something designers always yearn for. We designers love extremes. We wanted to make a real sports car, a fastback. Basically, we drew an M8 right away – and that became the 8 Series. We have given it a very high recognisability and independence as a sports car. The vehicle is shaped non-stop from the front via the door to the rear fender. We have

limited ourselves in the sculpture to very few lines. Above the rear wheel grows a very muscular and very sensual surface. This enabled us to achieve what we had set for ourselves: We have designed a dream car.

High performance and maximum luxury – how does it fit together? Aren't they opposites?

No, not with us. M always stands for the most expressive version of the vehicle – both aesthetically and in terms of performance. M pushes the controller in the direction of radicality. Not only in terms of performance, but also in terms of the expressiveness and extroversion of the equipment, materials and colours. The most luxurious BMW M8 is also the most powerful. Because luxury is always more than you need: more power, more comfort. Best materials, best workmanship. High performance and luxury are a perfect match for me.

DOMAGOJ DUKEC
CHIEF DESIGNER FOR BMW.

EVERY VIEW IS AN UNFORGETTABLE EXPERIENCE.



A SPORTING PROMISE AT 5098 MILLIMETRES: THE NEW BMW M8 GRAN COUPÉ.

The terms sportiness, luxury and comfort are not superlatives in themselves. There is, however, one vehicle in which they unite to form one: the first BMW M8 Gran Coupé – the most elegant and uncompromising symbiosis of everything that BMW and the letter M stand for.

A promise right from the start: What takes up space on the next 5098 millimetres is an extremely self-confident statement. The M specific kidney grille identifies the uncompromising high-performance athlete: Flat, hexagonal and with the M typical double slats, it sits enthroned in the centre of the attention-grabbing front, which seems to be ready to jump. Together with the M specific front apron underneath, it sets an example of absolute top performance: The high-performance engine and brakes are at home at the physical limits and require a lot of air for effective cooling.



If you look at the side line, the independent character of the new BMW M8 Gran Coupé immediately catches your eye: Four doors testify to size and unsurpassed comfort for the driver and all passengers. A flowing roofline in a sophisticated combination with an elaborate, sculptural shoulder section underlines the sporty elegance of this exceptional vehicle. The next eye-catcher are the 20" M light alloy wheels Star-spoke style 811 M Bicolour^{1, 2}, whose gloss-milled surfaces provide that extra something. The long wheelbase also highlights the superior size of the new BMW M8 Gran Coupé. The sight of the side line is rounded off by a series of striking details. In the Air Breathers, for example, M specific gills are integrated which, like the trim elements in the outer air inlets, refer to the shape of the dynamic sharknose. This way the vehicle is already visually accelerated. The M typical double-bridged exterior mirrors in vehicle colour also enhance the overall dynamic appearance of the vehicle – at least as much as the anticipation: Anyone who gets in and drives off will experience that the BMW M8 Gran Coupé even effortlessly exceeds its visual promises in terms of driving dynamics.

¹ Available as optional equipment.
² Standard for Competition models.

Unconditional sportiness versus maximum comfort: The balance between the pros and cons of these two vehicle characteristics is history and for all, because the first BMW M8 Gran Coupé combines both worlds confidently, powerfully and without the slightest compromise.

In normal cars, you simply get in. With the new BMW M8 Gran Coupé, you enter a highly dynamic world that wants to be experienced with all your senses. The illuminated "M8 Competition" inscription¹ on the door sill finisher is unmistakable proof of this. If you take a seat on the M Sport seats with the M8 badge, which is also illuminated, you will immediately feel close to motor sports. The pronounced side bolsters and the strikingly flared shoulder area of the seats, which immediately create a racetrack atmosphere, also contribute to this. As a driver you are now in the centre of the action: All functions and displays relevant to driving are consistently geared to the person behind the wheel. And last but not least the grip of the M specific gear selector in leather with contrast stitching and ambient light creates this extremely stimulating tingling sensation as an anticipation of an incomparable experience.

The exclusive feeling of sitting in a BMW M8 Gran Coupé – and feeling it at every moment – is by no means reserved for the driver alone. If you follow the continuous centre console, which extends from the instrument panel between the driver and front passenger to the rear seats, you immediately realise what true legroom means. The effects of the long wheelbase come to the fore in the rear – surrounded by precious materials processed to the highest standards of craftsmanship – and enable a space that can only be described as truly luxurious. At the same time, the single-seat character of the contoured rear seats never lets you forget that you are on the road in an extremely sporty vehicle – an M that shows its true greatness.

THE REAR OFFERS A SPACE THAT CAN ONLY BE DESCRIBED AS TRULY LUXURIOUS.

¹ Only available for Competition models.

THE BEGINNING OF SOMETHING BIG:
THE END OF ALL COMPROMISES.



“

THE SOUND MUST BE UNIQUE
 THE SOUND MUST BE UNIQUE
 THE SOUND MUST BE UNIQUE
 THE SOUND MUST BE UNIQUE
 THE SOUND MUST BE UNIQUE
 THE SOUND MUST BE UNIQUE
 THE SOUND MUST BE UNIQUE
 THE SOUND MUST BE UNIQUE
 THE SOUND MUST BE UNIQUE

The new BMW M8 Gran Coupé is a sports car for aesthetes. This also applies to the sound. From particularly sporty to extremely elegant, the sound embodies all the characteristics of a dynamic luxury sports car. Highest quality and maximum performance – what does that sound like in a BMW? A visit to the BMW Sound Masters at the test site in southern France.

The BMW Autodrome de Miramas test site in southern France is a world of its own. Whoever enters it is immersed in a microcosm of prototypes. Almost every car that drives here is still secret – and therefore camouflaged. Taped completely or partially with psychedelic-looking foil in the colours black and white. Like in a science fiction film, car and motorcycle prototypes rush past on different courses. Turning up in steep bends, scurrying along crash barriers, parking cleanly in rows or accumulating in front of barriers that open as if by magic or not, because the test tracks behind them are currently exclusively occupied. For example by Dr. Robert Liebing and his team, the sound designers from BMW.

There are no coincidences in the sound. Robert Liebing at BMW is responsible for the “Sound Design Development of the Complete Vehicle”. The 39-year-old is responsible for all the effects and sounds you hear from inside and outside a BMW – the engine’s drive noises, the sound signals of the control functions in the car, the ticking of the indicator. None of these sounds are left to chance. Especially not when a vehicle is so consistently designed for performance and luxury as the BMW M8 Gran Coupé.

Controlled speed, highest dynamics, outstanding elegance. The four-door BMW M8 Gran Coupé combines the motorsport genes of BMW M with the luxurious standards of the BMW 8 Series. It appeals to all the senses – and sound plays an important role in this: “The sonic perfection of the BMW 8 Series involves a great deal of work and all the enthusiasm of those who do it. All BMW 8 Series models, from diesel to six-cylinder to eight-cylinder petrol engines, have a characteristically unmistakable sound,” says Robert Liebing. “The M8 has the best sound – in tone, volume, response characteristics.”

Step by step, the acoustic designers in Miramas approach the perfect sound experience. 30 per cent of the work is done on the computer, 70 per cent is classic testing. Drive, drive, drive. The most important aid is a special headphone set with external microphones that the sound designers wear during the test drives. “We need these headphones to fine-tune what the car reproduces so that we can capture it acoustically and then analyse it,” explains Daniel Schock, “Sound designer in charge of the premium class sound design” and the man for the BMW 8 Series in Liebing’s team. Liebing nods. “Experts like Daniel can hear a lot of things per se. But sometimes you just need the exact measurement to find out: What exactly is this now that’s bothering me here? Especially the octaves are difficult to distinguish by hearing. Is it a second or fourth engine order?”, says the sound expert.

“Orders” are the acoustic fingerprint of an engine. Boxer, inline six, V8 – all engines have different weightings due to their rotating parts and thus a different specific sound. “With increasing speed, the engine sound must rise upwards,” describes Schock. “The sound must unfold like a bouquet of flowers. The sound needs to get richer. More enticing. If it’s up to me, I’d like it to be a little angry too.”

The sound pays for the weight

In the BMW M8 Gran Coupé, the driver can and should hear much more from the engine than in the other 8 Series models. Rule of thumb: The larger the engine in a vehicle, the more drive feedback the customer wants and the more he can and should hear from the engine. Welcome advantage: With the BMW M models, insulating material and thus weight can be saved. This is reflected positively in the output balance.

In addition to classic adjusting screws such as the exhaust system, engine mounts also play an important role in sound design. Liebing explains: “These mounts have the task of insulating the engine from the chassis, so they have an influence on what the driver receives in the structure-borne sound range.” The 600 hp engine of the BMW M8 Gran Coupé therefore has stiffer engine mounts than the normal eight-cylinder and six-cylinder engines, as even greater emphasis is placed on driving dynamics and drive feedback.

Two sound worlds, one sound experience

Another special feature of the BMW M8 Gran Coupé: It’s a real four-seater. A vehicle that offers a lot of space. In the rear there are also people who, unlike the driver, do not have the desire to be included into the acoustic driving experience. Liebing and his team therefore strove to achieve the balancing act of creating a sound that generates direct feedback from the drive in row one and ensures greater acoustic comfort in row two.

It doesn’t matter if you sit in front or behind: The drive noise must never sound strained. “BMW vehicles stand for sportiness and dynamism,” says Robert Liebing. That is why we have particularly emphasised their natural free-revving character.

“The sound must symbolise power and the free-revving character, which is very important for a BMW,” says Liebing, who earned his doctorate in psychophysics as an electrical and communications engineer. “We have done a good job when the sensory impressions form a coherent overall picture, when they are all equal and do not outdo each other. Then the driving experience becomes all-encompassing.” But first of all there will be some more laps on the test area of the Autodrome de Miramas – until everything is right and all the sounds fit together like at a concert.

THE PHILOSOPHY OF ABSOLUTE PERFORMANCE.



Built to be first. And that's exactly how the BMW M8 Gran Coupé drives: Engine, suspension, operating concept and all components relevant for driving are designed to create a comfortable and sporty driving experience in perfect interaction that words can only begin to describe – that you simply have to experience for yourself.

M TwinPower Turbo 8-cylinder petrol engine: in the heart of pure power.

The M TwinPower Turbo 8-cylinder petrol engine in the new BMW M8 Gran Coupé is the most powerful V8 engine ever developed by BMW M GmbH for a production vehicle. Its 8-cylinder V-engine with M Twin-Scroll TwinTurbo technology in the Competition model delivers up to 460 kW (625 hp) on the road, pushing this exceptional vehicle forward with a breathtaking 750 Nm of torque. Every detail is not just suitable for the racetrack, but absolutely designed for it: Consistently lightweight with two highly dynamic turbochargers, high-pressure direct injection, Valvetronic and a proven cooling concept, the engine creates a driving experience that even professionals dream of: Its direct, fast response, linear power characteristics and constant high torque at low revs ensure absolute dominance at all times – a dominance that even spectators will remember for a long time thanks to the highly emotional and pronounced broadband external sound.



Euphoria is a question of attitude: M Setup.

Engine, steering, suspension, brakes – in the new BMW M8 Gran Coupé, all components are optimised for maximum, unfiltered pleasure. With the M Setup, the driving behaviour can be even further improved in terms of dynamics: Be it comprehensive driving stabilisation, controlled sporty "M dynamic mode" or complete deactivation of all driving stabilising systems – here you will find the perfect setting for every situation. The M xDrive all-wheel-drive system also offers two different modes or pure rear-wheel drive – a setting that guarantees maximum driving pleasure, especially on racetracks. Preconfigured in the M Drive menu, these functions can also be selected directly via the M1/M2 buttons on the M leather steering wheel – because in the new BMW M8 Gran Coupé, every moment holds the potential for absolute driving pleasure.

M xDrive with Active M Sport differential: more than all-wheel drive.

The intelligent all-wheel-drive technology M xDrive with Active M Sport differential plays an equally important role. In the new BMW M8 Gran Coupé, power is distributed between the front and rear axles in fractions of a second. Depending on the selected configuration and the interaction with the M Sport differential, the focus is on optimum controllability and agile, playful handling, always in combination with outstanding traction and absolute control. The result is a dynamic driving experience that makes the racing character of the new BMW M8 Gran Coupé impressively tangible in every respect.



THE UNCONVENTIONAL THINKER.

Tyler Brülé has already turned the lifestyle world upside down several times. The editor-in-chief of the globally successful “Monocle” magazine loves to take surprising positions and find new perspectives with his projects. In conversation, he reveals how he implements his visions – and what progressive luxury means to him.

Canadian journalist and entrepreneur Tyler Brülé stands like no other for an optimistic, intelligent and independent lifestyle. With the founding of the “Wallpaper” magazine in 1996, he set the tone for style-oriented and globalised reporting. In 2007, he founded “Monocle”, another successful international magazine. He gradually expanded the brand to include books, radio, travel guides, shops, fashion and accessories and is now considered one of the most important lifestyle icons.

Mr. Brülé, through your work you became the first global lifestyle citizen. Someone who feels just as comfortable in a bar in Seoul as in a bicycle shop in Kyoto. Do you also live as you describe it in your magazines?

I think good editors-in-chief always do what they enjoy doing. They embody the magazine. We’ve translated what interests me into a magazine format. We wanted to be curious about the world in all its breadth.

You were always an unconventional thinker, you never focused on popular trends, but liked to swim against the current. How do you succeed in launching printed journals again and again at a time when everyone is fixated on digitisation?

My first company was “Wallpaper” in 1996. I just wanted to make a magazine, I was totally excited about it. Despite the digital wave that rolled towards us at that time, I was firmly convinced that it would work. I used to work as a journalist, not as a publisher! Although

“IT’S VERY IMPORTANT TO GO OUT, TRAVEL, GAIN EXPERIENCE.”

I did not come from a wealthy family, a bank gave me a loan of 100,000 pounds. I owned 100 percent of the magazine, later I sold it. Despite the success of “Wallpaper”, the founding of “Monocle” in 2007 was viewed with suspicion, at least in the English-speaking world. But again I was sure that there was a market for this magazine – among globalised, optimistic readers who are open to new opportunities. Today we are still successful, launching shops, conferences and other magazines under the “Monocle” brand.

“Wallpaper” told less stories about luxury products than about the movers and shakers and their visions of how they were breaking new ground. With “Monocle” you continued this, often small start-ups are introduced that do something different. What would you tell someone who wants to start their own business?

It is very important to go out, travel, gain experience and identify benchmarks. Anyone who opens a new store or launches a product on the market has to look for inspiration outside. That doesn’t mean you’re copying anything. And you need passion. If you’re burning for something, it’s probably something worth pursuing. You need people who pull together. And don’t trust every management guru and start-up speaker who celebrates creative tension, conflict culture and disruption. With all the dynamism, you need a qualitative basis, a reliability to be progressive.

What was your greatest success as an entrepreneur?

I cannot point to the one big thing, it’s rather that our philosophy has proven to be successful. An entrepreneur does not have to do pioneering work every day of the week, even if many think so. There were General Interest magazines before us, but what’s special about “Monocle” is its style, the spirit of the magazine, which appeals to optimistic, open-minded and entrepreneurial people. Another success has been that we have not jumped on every digital train. We concentrated on our strengths in the print sector and expanded our Internet radio – and did well with it.

For your work, you spend about 50 percent of your life travelling. Is that easy for you?

We are an owner-managed company, so I can travel as I please. That’s a privilege. But today I travel differently than before. I try to be in Zurich for a longer time and then do all my trips en bloc if that is possible. That works much better. But of course it is part of my job to be on the road and meet many people personally.

Your successful “Monocle” radio broadcasts are just perfect on the road. You have been managing with audio media for years before podcasts came into fashion.

Yes, it almost killed us at first. It’s fully ad-financed, and it’s been up and down. But for me, audio, not the tablet, is the digital counterpart to a magazine. It’s sensual, and you have the voices that you like to listen to when they develop a good narrative. And it is relatively easy to produce compared to multimedia. We needed stamina to do it, but today it’s really justified by the podcast wave.

What else is important to you when travelling?

I like it when things I encounter along the way have character. Japan is the best example. I like being there often. I appreciate their very own tendency to perfection and their concentration on quality. In the past, in the Ryokans, the traditional guest houses, there were only tatami mats and pillows, quite simple and beautiful. This should not be westernised, or adapted to international comfort by putting in a sofa, for example, as sometimes happens.

What does progressive luxury mean to you?

A modern kind of luxury for me is to have roots. I can be progressive because I live in a city that really works, that is efficient and dynamic at the same time, like Zurich. I don’t miss anything there. There is a lake I could jump into at any time, and my way to the office takes two minutes. This has a big influence on my quality of life and, I suppose, also on my health.

Is it also a luxury for you to run your own business and to fulfil yourself through it?

Entrepreneurship is not for everyone. You are responsible for everything, from typing errors to printing deadlines up to delivery to Ms. Müller in Stuttgart. If something goes wrong, it’s always my fault in the end. That causes enormous pressure. If you can handle it, then of course the gratification is enormous.



Success story: “Monocle” has established itself as a lifestyle magazine for demanding jet-setters.



03

EMOTION EXPRESSED AS INNOVATION.

THOUGHTS WERE BORN, IDEAS BROUGHT TO A CONCLUSION AND KNOW-HOW TAKEN TO THE EXTREME. INNOVATIVE TECHNOLOGIES WERE DEVELOPED, COMFORT AND EFFICIENCY ENHANCED AND PERFORMANCE LEVELS INCREASED. BUT ALL THIS WAS NOT DONE TO PUT KNOWLEDGE, ABILITY AND PIONEERING SPIRIT IN THE FOREGROUND – BUT TO MAKE THIS ONE, SPECIAL FEELING EVEN MORE TANGIBLE: DRIVING PLEASURE. TECHNOLOGY BECOMES EMOTION – BAYERISCHE MOTOREN WERKE.

PERFECTION ON YOUR SIDE.

DRIVER ASSISTANCE



Challenging the laws of physics is part of the DNA of BMW M automobiles. This always includes a maximum amount of safety as well – as you have to be able to control power in every driving situation. The intelligent assistants of BMW Personal CoPilot are therefore also on board BMW M automobiles to support the driver on request and guarantee unlimited driving pleasure. Predictive technologies are in place to ensure that you always feel protected on the road, even when approaching the car's limits.



Driving Assistant Professional.

An athlete through and through – but at the same time outstanding in comfort and safety: Driving Assistant Professional^{1,3} combines numerous intelligent functions into an overall experience that is there when you need it, without diluting the typical sports car experience in the new BMW M8 Gran Coupé. The camera- and radar-based driver assistance system relaxes and supports in monotonous or confusing driving situations: The Steering and lane control assistant almost automatically keeps the vehicle in the right lane, while the Speed Limit Assist function automatically adopts the permitted speed. In the city, in turn, the Crossroads warning with brake intervention detects traffic lights, traffic signs and crossing vehicles and helps to reduce the impact speed in the event of an emergency. The driver can thus devote himself entirely to what makes the new BMW M8 Gran Coupé so special: a maximum sporty driving experience, safer, more comfortable and more luxurious than ever before.

BMW Laserlight.

The BMW Laserlight¹ in the new BMW M8 cars is impressive: The laser high-beam headlight module radiates over 500 metres and fully doubles of the light intensity compared to a Bi-LED. The blue accent clips inside the illuminated tubes as well as the “BMW Laser” logo point to the innovative laser light technology.

Parking Assistant Plus.

The Parking Assistant Plus¹ camera- and ultrasound-based assistance system simplifies the search for a parking space, parking, reversing and approaching exits and intersections thanks to the perfectly coordinated interaction of its sensors. For example, the system measures the size of possible parking spaces as it passes by. If a gap is large enough, the system takes over the vehicle guidance and parks the vehicle independently in parallel and perpendicular² parking spaces. Even more complex reverse drives are surprisingly relaxed: The Reversing Assistant automatically remembers the last 50 metres driven and steers independently when reversing, while you only have to accelerate and brake – ideal for winding driveways or narrow mountain roads, for example. With the Remote 3D View* function, you can even access the vehicle environment as a 3D view on your smartphone – ideal if you want to make sure that everything is okay with your new BMW M8 Gran Coupé while on the move.

¹ Available as optional equipment.

² The driver is responsible for constantly monitoring the automated parking procedure in accordance with local road laws.

³ Function may be limited in darkness, fog or bright glare.

* The availability of some equipment features and functions depends on engine variants or additional options. The market and production availability may vary. You can find detailed information about terms, standard and optional equipment at www.bmw.com or from your BMW Partner.



Automobiles by BMW M GmbH are a world of their own – and yet they are ever connected to the world of the driver. Receiving information whilst on the go, communicating via phone or email, or simply being spontaneously entertained: BMW ConnectedDrive can make it all happen. Whether making the most of the M Laptimer app and its racing functions, or enjoying the personal mobility assistant BMW Connected on your smartphone, the comprehensive interconnectivity and innovative operating concept with M specific functions enable even more comfort in everyday driving and personal bests on the race track.

BMW Display Key.

The BMW Display Key¹ for the M8 cars features a touch-enabled LCD colour display. This allows you to operate various functions, such as vehicle locking and Auxiliary heating¹, from a distance of up to 300 metres. In addition, range and vehicle locking information can be retrieved remotely.

BMW Live Cockpit Professional with BMW Operating System 7.0.

Everything in view, everything under control: The BMW Live Cockpit Professional combines a high-resolution 12.3" instrument display behind the steering wheel with a 10.25" Control Display in the centre console and the full-colour BMW Head-Up Display². All important information for the driver, such as navigation and vehicle data, are clearly displayed and ideally readable. The BMW Live Cockpit Professional runs the innovative operating system BMW Operating System 7.0, which enables individual configuration via widgets and spreads an adrenaline-charged racing atmosphere through an M specific, particularly dynamic font and M specific displays. It also makes operation particularly intuitive and convenient: No matter whether you communicate your wishes to your new BMW M8 Gran Coupé using the iDrive Touch Controller, touch control on the Control Display, gestures or voice via the BMW Intelligent Personal Assistant – all functions are reliably executed because your individual needs are always the most important priority.



M views.

The centre console provides a view of the essentials at the touch of a button: With the M Views, you can optimally adapt the appearance of the displays to the desired driving situation – and thus intensify the driving experience. In addition to the "Road" mode, there are two other modes available. Activate the "Sport" mode and focus your attention on elements such as the double revolution counter, along with elaborate animations at the optimum shift time. Available exclusively for the new BMW M8 Competition models, the "Track" mode further enhances visual focus by masking all functions that distract from the absolute racetrack feeling. Together with the powerful M typeface and the M specific colour gradations of red, a sports car dynamic emerges before your eyes that is difficult to escape.

Experience Modes.

The Experience Modes^{1,*} immerse the interior in one of four selectable moods by harmoniously orchestrating various functions such as lighting, air conditioning and music.

¹ Available as optional equipment.

² The information in the BMW Head-Up Display is not fully visible when viewed through polarised sunglasses. Content shown will depend on the equipment options chosen. Further optional equipment is required to display specific items.

* The availability of some equipment features and functions depends on engine variants or additional options. The market and production availability may vary. You can find detailed information about terms, standard and optional equipment at www.bmw.com or from your BMW Partner.



FOR THE EYES, FOR THE MIND.

CONNECTIVITY AND INFOTAINMENT



WHEN LUXURY MEETS EVERYDAY LIFE.

COMFORT AND FUNCTIONALITY



BMW M GmbH vehicles not only stand for unlimited driving pleasure, but also for particularly sophisticated motoring enjoyment. Everything around you is designed for maximum comfort, maximum functionality and a racing atmosphere. From atmospheric light design when entering the vehicle to perfect sound from the powerful high-end sound system to the M Sport seats for the best lateral support when cornering: Everything here is designed to turn even an everyday trip into an extraordinary and dynamic experience.



The Heat Comfort package in the first row of seats¹ always ensures maximum well-being. In addition to the seat heaters for driver and front passenger, heated armrests in the front doors and centre console are also available, as is steering-wheel heating, which gives the steering wheel rim a pleasant temperature.

Comfort access and BMW Digital Key.

Access to a whole new world: Comfort access¹ makes it easier to open and close your new BMW M8 Gran Coupé – and you don't even have to pick up the key to do so: As soon as it approaches three metres, the vehicle begins with a visual welcome presentation, and a sensor under the rear apron allows the tailgate to be opened and closed with a single foot movement. With the virtual BMW Digital Key², you can even manage without a physical key altogether: With a suitable smartphone and the BMW Connected App, you can not only open your new BMW M8 Gran Coupé easily and without complications, but also start the car as soon as the smartphone is in the centre console. The BMW Digital Key² can even be shared with up to five devices, giving selected users access to the vehicle – including the linking of individual driver profiles for each of the five digital keys.

Spaciousness.

In the new BMW M8 Gran Coupé, the intense, sporty driving experience is not limited to the front seats – rear-seat passengers also enjoy a driving experience that releases endorphins from the very first metre. This is especially due to the single-seat design of the rear seats, which is visually and functionally oriented to the seats in the cockpit. They offer ideal support and an enclosing seating feeling even on dynamic journeys. At the same time, they spread an unparalleled sports car atmosphere. The extended centre console, which extends from the cockpit to the rear in a flowing movement, even underlines this impression. Together with the fold-out centre armrest, it defines two discreet individual seats, each offering maximum seating comfort. Thanks to the 2+1 seat configuration in the rear, a third passenger can also experience the sportiness of the new BMW M8 Gran Coupé on shorter journeys.

¹ Available as optional equipment.

² Prerequisite is a BMW ConnectedDrive account and a compatible smartphone with Android operating system, NFC technology and integrated secure element. Only compatible with selected Android smartphones with Android 8.0 or higher. For customers with non-compatible smartphones, a high-quality key card is provided.





04

THE UNIQUE POWER OF THE MOST PERSONAL DETAILS.

NOTHING IS AS INDIVIDUAL AS EMOTIONS. IN A NEW BMW M8, THIS UNIQUENESS IS FURTHER OPTIMISED TO THE LIMIT – THROUGH A VARIETY OF POSSIBILITIES TO MAKE THE VISUAL AND HAPTIC EXPERIENCE OF SURFACES AND MATERIALS EVEN MORE DYNAMIC AND TO PERFECT IT FOR ONESELF. STRONG INSIGNIA AND UNIQUE MATERIALS, WHICH ARE BROUGHT DIRECTLY ONTO THE ROAD FROM RACING WITHOUT DETOURS, MAKE ANY RESISTANCE POINTLESS. LET YOUR FEELINGS RUN WILD – WE STRENGTHEN YOU WITH HP FROM DESIGN, ATTENTION TO DETAIL AND PERFECT CRAFTSMANSHIP.

THE NEW BMW M8 GRAN COUPÉ.

The new BMW M8 Gran Coupé can be found where even the highest expectations are exceeded. Never before has a BMW combined sportiness and elegance so self-confidently with superior size and the corresponding luxury. Every design line of the new BMW M8 Gran Coupé inevitably leads to speechless amazement and the realisation that only a journey in this icon can bring fulfilment.



20" M light alloy wheels Double-spoke style 810 M.

20" M light alloy wheels Double-spoke style 810 M Bicolour Orbit Grey with mixed tyres, gloss-lathed, front 9.5J x 20 with 275/35 R20 tyres, rear 10.5J x 20 with 285/35 R20 tyres.

BMW Individual paint finish Frozen Dark Silver metallic.

As if the varied surface play of the new BMW M8 Gran Coupé were not already enough visual seduction, the BMW Individual special paintwork Frozen Dark Silver metallic¹ further emphasises this impression. Elegant and silky, this matt paint creates the feeling of discovering new nuances depending on the incidence of light and the time of day.



M leather steering wheel.

Even with your hands, you can feel what your whole body is experiencing: The M leather steering wheel with gearshift paddles and M emblem in a sporty 3-spoke design has a feel borrowed from motorsport. The steering wheel rim in leather 'Walknappa' Black with contoured thumb rests provides a particularly sporty and direct steering feeling.

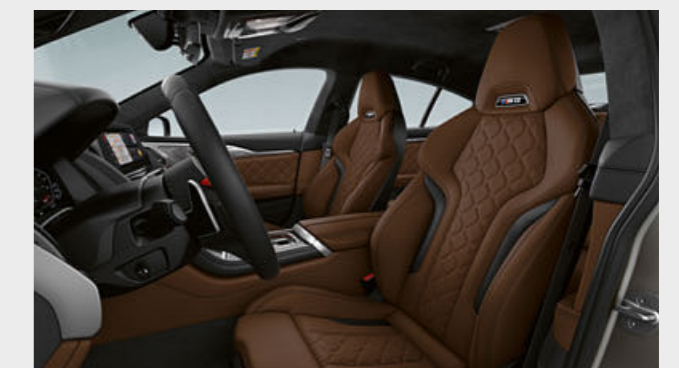

Full leather 'Merino' Taruma Brown.

As soon as you sit down in the new BMW M8 Gran Coupé in the M Sport seats with full leather 'Merino' Taruma Brown^{1,2}, you feel the perfect grip that more than meets the demands of a dynamic ride. The rich and deep colour of the leather creates a luxurious ambience that further underlines the vehicle's self-confident character.

¹ Available as optional equipment.
² Standard for Competition models.



THAT'S WHAT SUPERLATIVES
WERE INVENTED FOR.



THE NEW BMW M8 COMPETITION GRAN COUPÉ.

If the only requirement is to get the absolute maximum out of the shared DNA of BMW and M, the consequence is a vehicle that represents the top of the realm: the new BMW M8 Competition Gran Coupé. With a further increase in performance and a multitude of details that immediately catch the connoisseur's eye as subtle differences, we are confronted here with a BMW that deeply impresses in all respects and confidently inspires.

BMW Individual paint finish Ametrine metallic.

With the BMW Individual Ametrine metallic¹ paint finish, the new BMW M8 Competition Gran Coupé makes a statement that could hardly be more striking. The powerful colour accentuates the dynamic character of the vehicle and at the same time unfolds the long proportions and the varied styling of the entire body.

20" M light alloy wheels Star-spoke style 811 M.

20" M light alloy wheels Star-spoke style 811 M Bicolour Jet Black with mixed tyres, gloss-milled, front 9.5J x 20 with 275/35 R20 tyres, rear 10.5J x 20 with 285/35 R20 tyres.

BMW Individual interior trim finishers piano finish Black.

The BMW Individual interior trim finishers piano finish Black¹ add a special note to the interior. An elaborate, multi-layer painting process borrowed from piano production creates a surface whose brilliance and depth of colour catch the eye.

Full leather 'Merino' Silverstone.

The fine version of the full leather 'Merino' Silverstone spreads an atmosphere of sporty elegance in the interior of the new BMW M8 Competition Gran Coupé. An ambience that always conveys exactly the right level of dynamism, not least because of the gripping M Sport seats and the lines pointing in the direction of travel.

¹ Available as optional equipment.

BMW INDIVIDUAL.

THE EXPRESSION OF PERSONALITY.



An unusual colour hue for an exceptional vehicle: The BMW Individual paint finish in Ametrine metallic emphasises the special character of the new BMW M8 Gran Coupé in an eye-catching way. Countless metal flops in the added Xirallic effect pigment refract the light in iridescent nuances on every surface and every curve of the exterior – a visual treat that is unparalleled.



The BMW Individual headliner Alcantara anthracite lends the interior a luxurious ambience thanks to the unique look and feel of the high-quality material.



The BMW Individual full leather trim 'Merino' Ivory White/Tartufo with its two colours in combination with the BMW Individual piano finish Black interior trim finishers reinforces the exceptional standard of the interior. The feel and look of the flawless exclusive leather transform every ride into an even more unforgettable experience.

When true character comes into play, everything changes – and everything becomes possible: Because you know best what really suits you. BMW Individual offers you all the options you need to turn your vision into a mobile reality. Extraordinary paint finishes with unique effect pigments intensify the appearance of your new BMW M8 Gran Coupé at first glance. In the interior, trims made of the finest woods, upholstery in high-quality BMW Individual leather quality and selected design elements set exclusive highlights. The result is a vehicle that suits you like no other. It is therefore unlikely that you will ever come across a second BMW M8 Gran Coupé that looks like your car. With BMW Individual, everything revolves around your individual idea for the new BMW M8 Gran Coupé, because we create unique specimens.

WHICH COLOUR GIVES YOU DRIVING PLEASURE?

Ametrine metallic or Motegi Red metallic? Brands Hatch Grey metallic or Frozen Cashmere Silver metallic? For whichever paintwork you decide: You always choose ground-breaking design and uncompromising dynamics, which prove passion and character.

■ STANDARD EQUIPMENT □ OPTIONAL EQUIPMENT

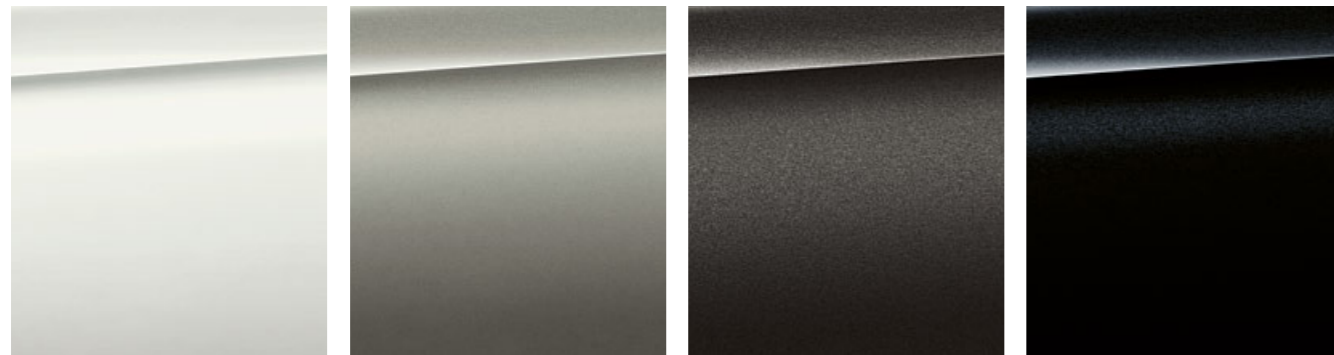

■ Non-metallic 300 Alpine White ■ Metallic C28 Donington Grey ■ Metallic C17 Brands Hatch Grey ■ Metallic 475 Black Sapphire

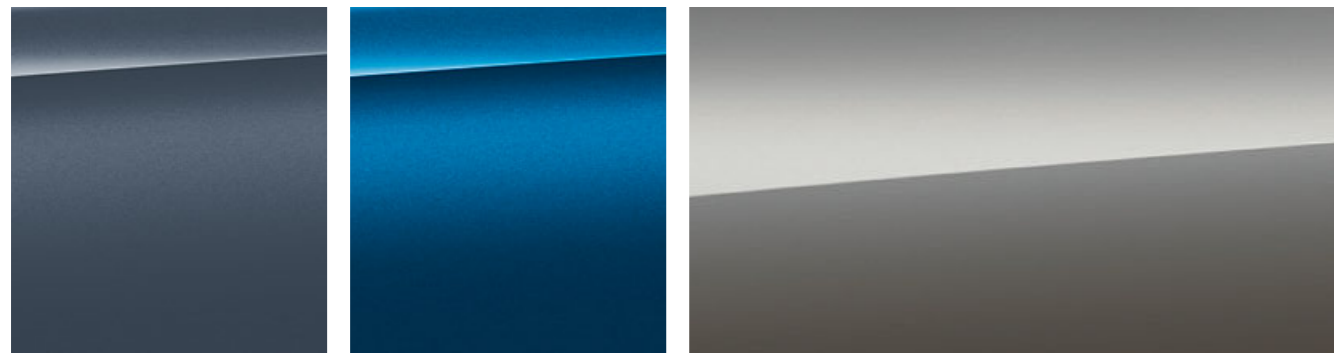

■ Metallic C38 Barcelona Blue ■ Metallic C1A Sonic Speed Blue

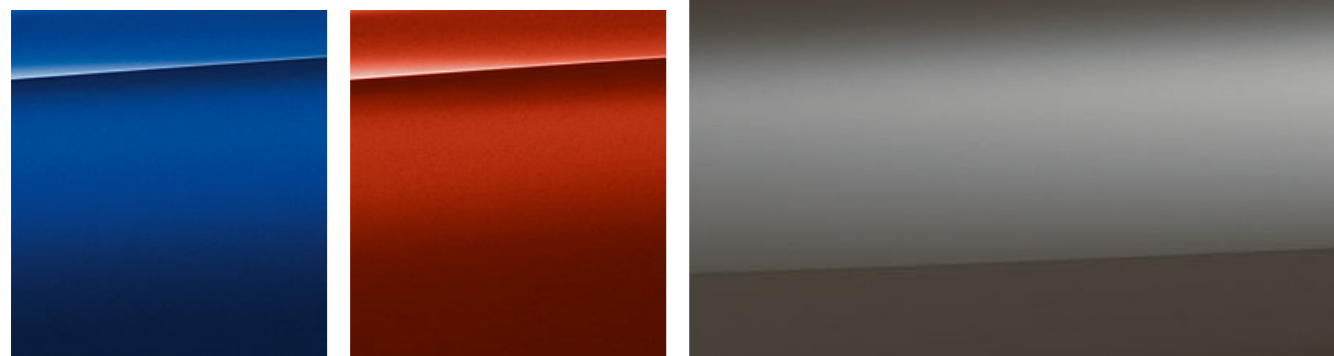

■ Metallic C1K Marina Bay Blue ■ Metallic C3K Motegi Red

BMW INDIVIDUAL



□ BMW Individual special paintwork Pure metal Silver □ BMW Individual special paintwork Brilliant White metallic □ BMW Individual special paintwork Frozen Brilliant White metallic □ BMW Individual special paintwork Frozen Cashmere Silver metallic

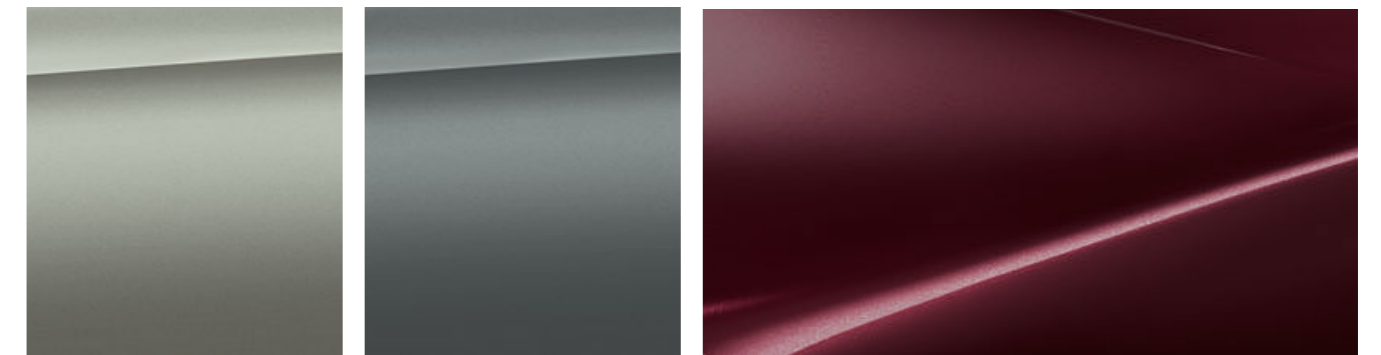

□ BMW Individual special paintwork Frozen Dark Silver □ BMW Individual X1D Frozen Bluestone metallic

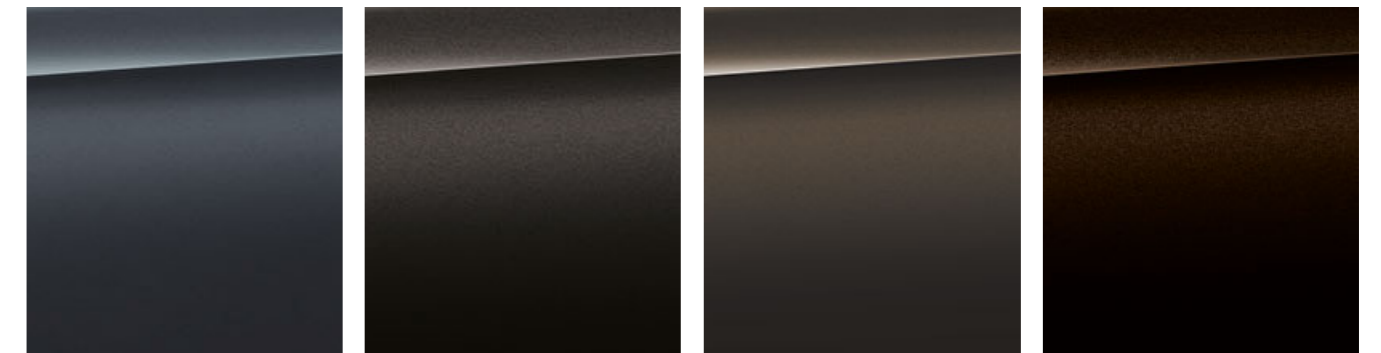

□ BMW Individual special paintwork Frozen Arctic Grey metallic □ BMW Individual special paintwork Frozen Dark Brown metallic □ BMW Individual C36 Dravitt Grey metallic □ BMW Individual C46 Almandine Brown metallic

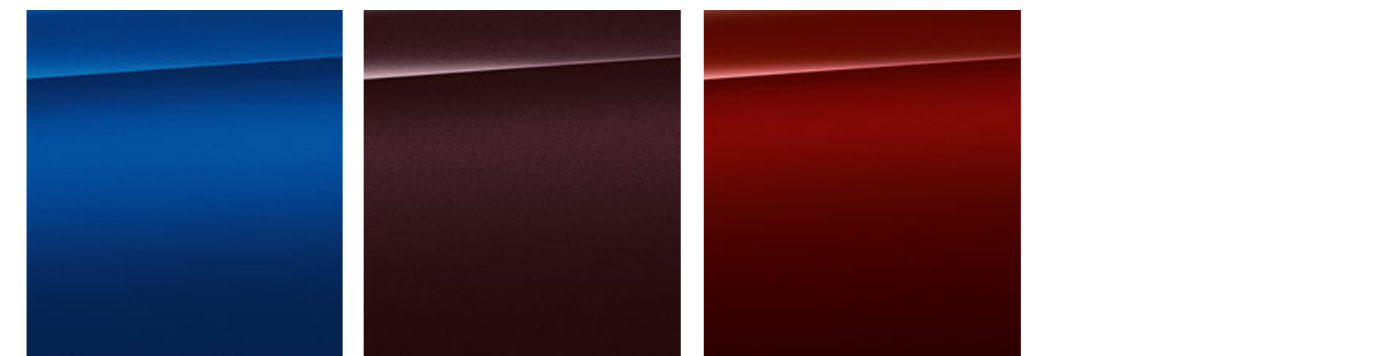

□ BMW Individual special paintwork Frozen Marina Bay Blue metallic □ BMW Individual X1B Ametrine metallic □ BMW Individual X1C Aventurine Red metallic

[Colour samples] These colour samples are intended as an initial guide to the colours and materials available for your BMW. However, experience has shown that printed versions of paint, upholstery and interior trim colours cannot in all cases faithfully reproduce the appearance of the original colour. Please discuss your preferred colour choices with your BMW partner or in your dealership. There you can also see original samples and be assisted with special requests.

THE MOST PERSONAL WAY TO SHOW STYLE.

Be it BMW full leather 'Merino' Silverstone combined with an interior trim finisher in fine-wood trim Ash Grain grey metallic high-gloss or another exquisite combination – a harmonious interplay of colours and materials in the interior will be your companion on all journeys.

■ STANDARD EQUIPMENT □ OPTIONAL EQUIPMENT

UPHOLSTERY COLOURS

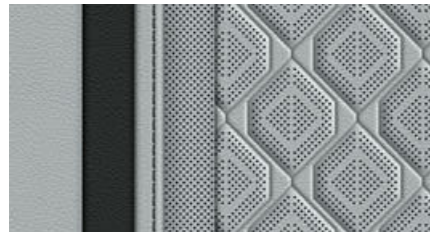

■ Leather 'Merino' LKA9 with extended contents Silverstone Bicolour

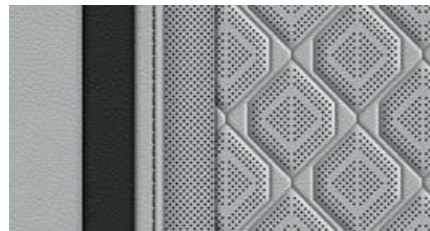

□ Full leather 'Merino' X3A9 Silverstone¹

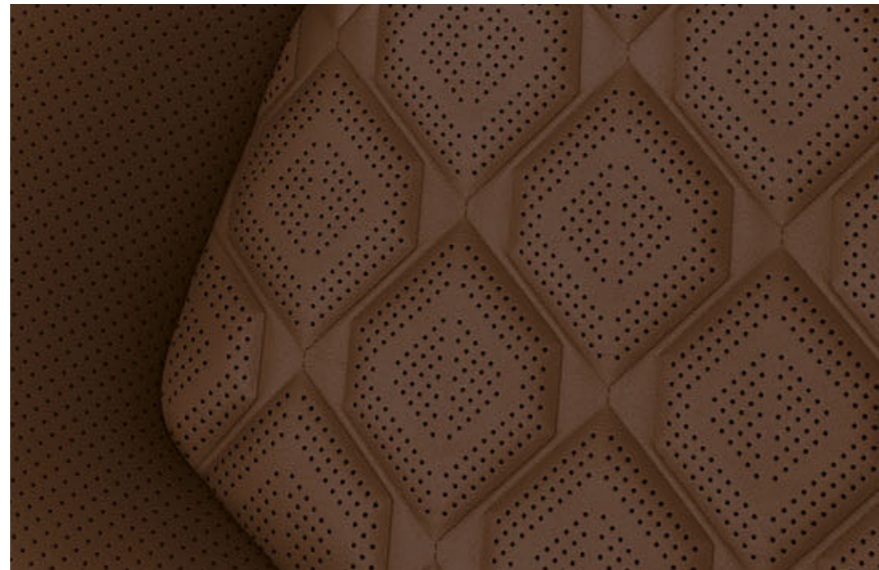

■ Leather 'Merino' LKSW with extended contents Black



□ Full leather 'Merino' X3SW Black¹

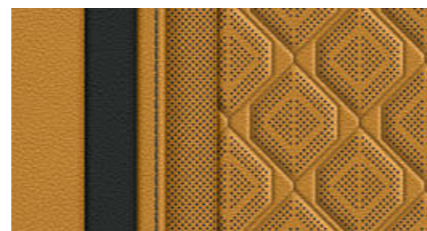

□ Full leather 'Merino' X3JQ Midrand Beige¹

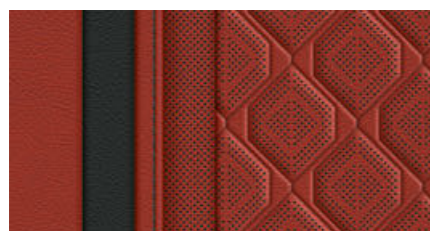

□ Full leather 'Merino' X3DA Sakhir Orange¹

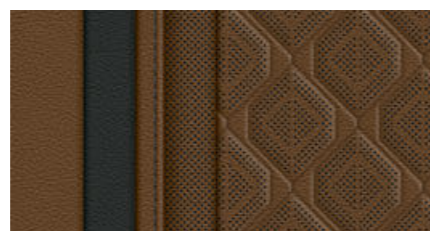

□ Full leather 'Merino' X3JT Taruma Brown¹

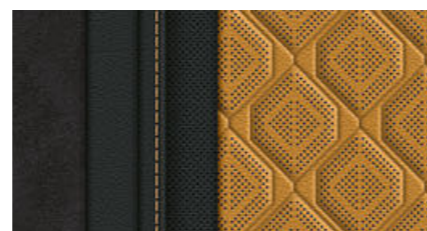

■ Full leather 'Merino' Alcantara combination HEJA Black/contrast Midrand Beige²

Please note that even normal long- or short-term use can lead to unrecoverable upholstery damage. This can be caused in particular by non-colourfast clothing.

BMW Individual full leather trim Merino includes front and rear seats, headrests, door trim, centre console including armrests and lower part of the instrument panel. Upper part of the instrument panel, top of the door panel and door panelling in leather cover.

BMW INDIVIDUAL LEATHER

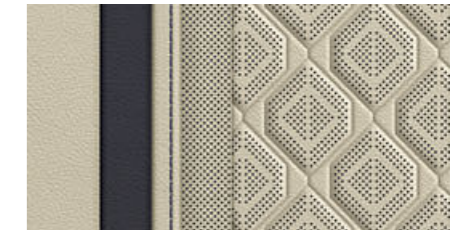

□ BMW Individual full leather trim 'Merino' ZBEI Ivory White/Midnight blue, interior colour Ivory White*

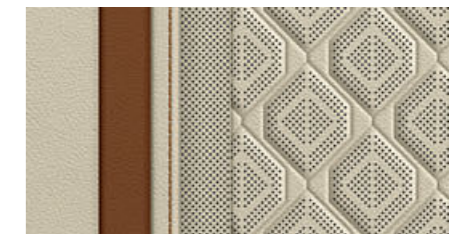

□ BMW Individual full leather trim 'Merino' ZBEJ Ivory White/Tartufo, interior colour Tartufo*

INTERIOR TRIM FINISHERS

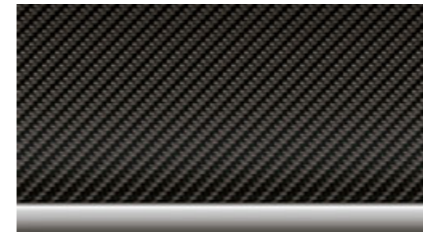

■ Interior trim finishers 'Carbon Fibre' on the centre console



□ Interior trim finishers fine-wood trim ash grain grey metallic high-gloss on the centre console

BMW INDIVIDUAL INTERIOR TRIM FINISHERS



□ BMW Individual interior trim finishers fine-wood trim Ash black silver effect high-gloss on the instrument panel



□ BMW Individual interior trim finishers piano finish Black on the centre console



BMW INDIVIDUAL HEADLINER

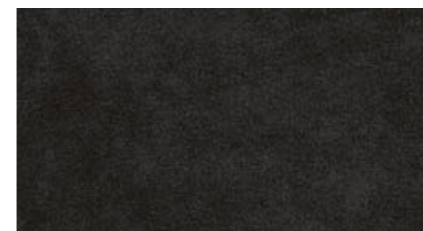

■ BMW Individual headliner 776 Alcantara Anthracite



□ BMW Individual headliner XD5 Alcantara Ivory White*

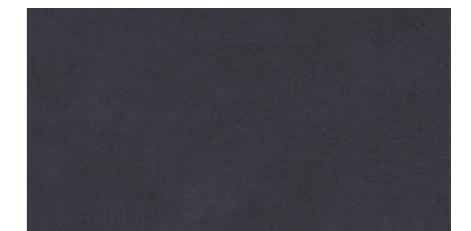

□ BMW Individual headliner XD5 Alcantara Night Blue*

¹ Standard for Competition models.

² Exclusively available for Competition models.

* The availability of some equipment features and functions depends on engine variants or additional options. The market and production availability may vary. You can find detailed information about terms, standard and optional equipment at www.bmw.com or from your BMW Partner.

TECHNICAL DATA.

	M8 Gran Coupé	M8 Competition Gran Coupé
Weight		
Unladen weight EU ¹	kg 2055	kg 2055
Maximum permissible weight	kg 2440	kg 2440
Permitted load ²	kg 460	kg 460
Luggage capacity	l 440	l 440
Engine		
Cylinders/Valves	8/4	8/4
Capacity	cm ³ 4395	cm ³ 4395
Max. output/engine speed	kW (hp)/rpm 441 (600)/6000	kW (hp)/rpm 460 (625)/6000
Max. torque/engine speed	Nm/rpm 750/1800–5600	Nm/rpm 750/1800–5860
Power transmission		
Type of drive	All-wheel	All-wheel
Standard transmission	Steptronic Sport transmission	Steptronic Sport transmission
Performance		
Top speed	km/h 250 ^{3,4}	km/h 250 ^{3,4}
Acceleration 0–100 km/h	s 3.3	s 3.2
Consumption^{5,6}. All engines conform to the EU6 standard		
Combined	l/100 km 11.1–11.2	l/100 km – ⁷
Exhaust emissions standard (type-certified)	EU6d-temp	EU6d-temp
Combined CO ₂ emissions	g/km 253–256	g/km – ⁷
Tank capacity, approx.	l 68	l 68
Wheels/tyres		
Tyre dimensions	Front: 275/35 ZR20 Y Rear: 285/35 ZR20 Y	Front: 275/35 ZR20 Y Rear: 285/35 ZR20 Y
Wheel size	9.5 J x 20 / 10.5 J x 20	9.5 J x 20 / 10.5 J x 20
Material	Light alloy	Light alloy

BMW M8 GRAN COUPÉ

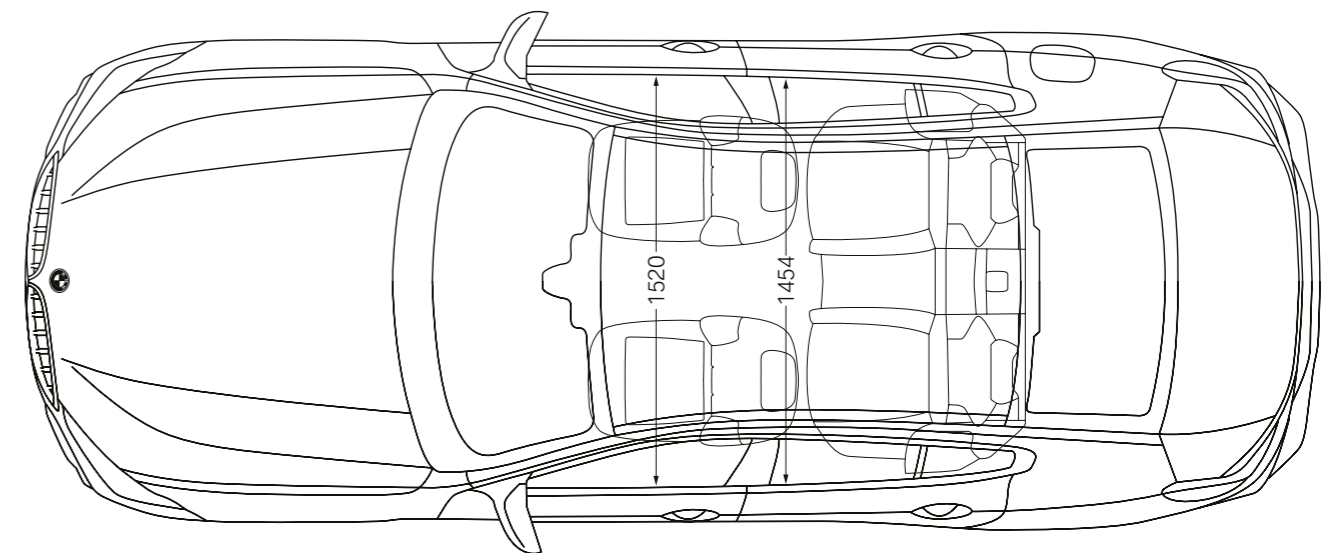
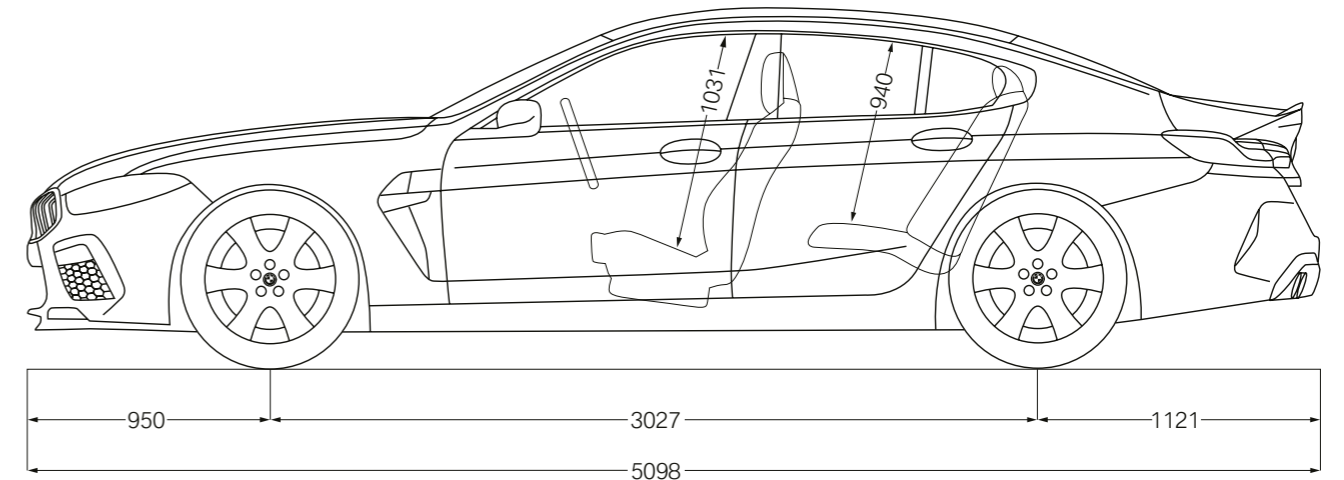
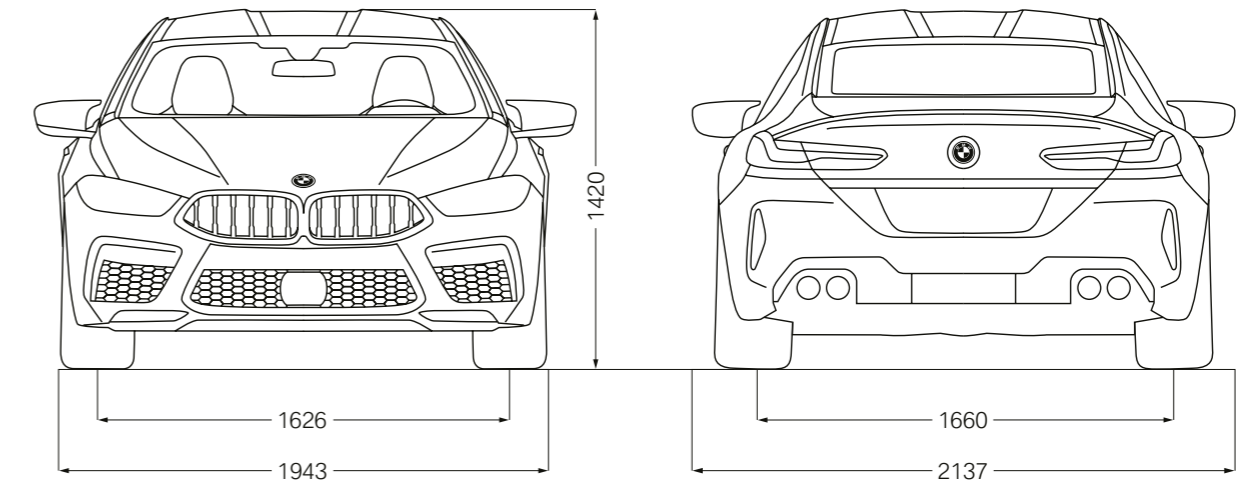

¹ The EC unladen weight refers to a vehicle with standard equipment and does not include any optional extras. The unladen weight includes a 90% full tank and a driver weight of 75 kg. Optional equipment may affect the weight of the vehicle, the payload and the top speed if the selected equipment has an impact on the vehicle's aerodynamics.
² The actual permitted load depends on the actual unladen weight and the maximum permissible weight of the vehicle (see vehicle registration and type plate on the passenger-side B-pillar) and should be determined by every customer himself. Optional equipment may affect the actual unladen weight and the remaining permitted load.
³ Electronically limited.
⁴ In combination with M Driver's Package, the top speed is increased to 305 km/h.
⁵ Performance data of petrol engines apply to vehicles using RON 98 fuel. Fuel consumption data apply to vehicles using reference fuels in accordance with EU Regulation 2007/715. Unleaded RON 91 and higher with a maximum ethanol content of 10% (E10) may also be used. BMW recommends RON 98 super plus unleaded petrol.
⁶ The data for fuel consumption, CO₂ emissions and energy consumption are determined in accordance with the measurements processes as defined by European Regulation (EU) 715/2007 in the applicable version. Data refer to a vehicle with base-level equipment in Germany, and the ranges account for differences according to the selected wheel and tyre size and the optional equipment. For these vehicles, values other than those specified here may apply for the assessment of taxes and other vehicle-related charges that are (also) based on CO₂ emissions. Version 10/11/2019.
⁷ This engine version is not available in all countries. Please contact your local BMW partner for more information.



The models illustrated in this brochure show the equipment and configuration options (standard and optional) for vehicles produced by BMW AG for the German market. Alterations in standard and optional equipment and the configurations available for the different models, as described in this brochure, may occur after 09/03/2019, the editorial deadline for this brochure, or according to the specific requirements of other markets. Your local BMW Partner is available to provide further details. Subject to change in design and equipment.

Of course, each vehicle is designed for economical recycling after its long-running life. You can find more information regarding your end-of-life vehicle on our website www.bmw.com/recycling.

© BMW AG, Munich, Germany. Not to be reproduced wholly or in part without prior written permission of BMW AG, Munich.
4 11 015 221 36 2 2019 CB. Printed in Germany 2019.

BMW M8 Competition Gran Coupé:

M TwinPower Turbo 8-cylinder petrol engine, 460 kW (625 hp), 20" M light alloy wheels Star-spoke style B11 M Bicolour with mixed tyres, exterior colour in BMW Individual Ametrine metallic, M Sport seats in full leather 'Merino' Silverstone, BMW Individual interior trim finishers piano finish Black.

