



Sheer
Driving Pleasure



THE X4

THE BMW X4.



DIGITAL DISCOVERY: THE NEW BMW BROCHURES APP.



More information, more driving pleasure: The new BMW brochures app offers you a brand new digital and interactive BMW experience. Download the BMW brochures app for your smartphone or tablet now and explore new perspectives of your BMW.

INNOVATION AND TECHNOLOGY.



18 Dynamics and efficiency
19 Drivetrain and suspension



20 Driver assistance
21 Safety



22 Connectivity and infotainment
23 Comfort and functionality

EQUIPMENT.



24 Models and lines



30 BMW Individual



32 Additional equipment

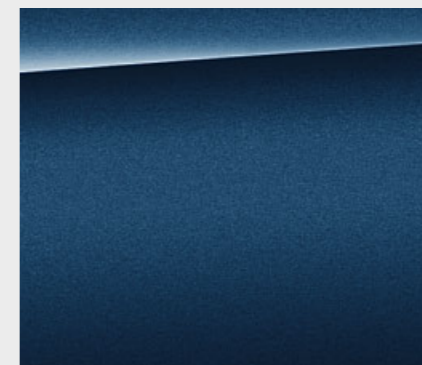

36 Exterior Colours

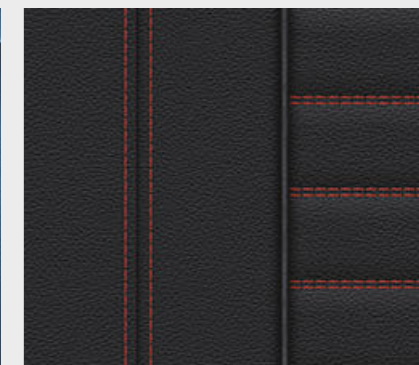

38 Interior Colours



40 Wheels and tyres



41 Original BMW Accessories

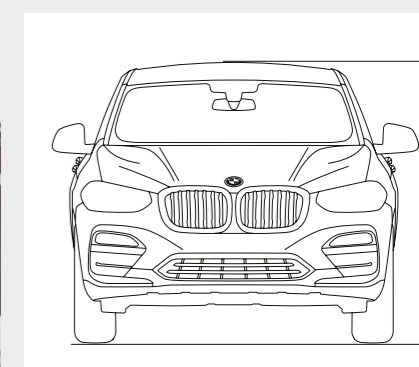

42 Technical data

DYNAMICS
X DESIGN.



FULL FORCE
AHEAD.





HIGH DESIGN,
HIGH SPEED.





PLACE OF RETREAT
FOR EXTROVERTS.



FINALLY SOMEONE
WHO UNDERSTANDS YOU.





THE MOST
BEAUTIFUL PLACE
IN TOWN.





BRING IT ON.
THE BMW X4.

SELF-ASSURED ATHLETIC EXTERIOR DESIGN SPORTY SILHOUETTE AND AERODYNAMIC KIDNEY GRILLE || FULL-LED FRONT HEADLIGHTS AND REAR LIGHTS || 21" LIGHT ALLOY WHEELS¹. **BRILLIANT PERFORMANCE** 50:50 WEIGHT DISTRIBUTION FOR IDEAL AGILITY || BMW xDRIVE WITH ACTIVE M SPORT DIFFERENTIAL² || M PERFORMANCE FOR MORE ATHLETICISM. **INNOVATIVE ASSISTANCE SYSTEMS** DRIVING ASSISTANT PLUS* || STEERING AND LANE CONTROL ASSISTANT^{1,*} || CROSSROADS WARNING^{1,*} || PARKING ASSISTANT PLUS*. **EASY CONNECTIVITY** 10.25" CONTROL DISPLAY WITH TOUCH CONTROL^{1,*} || GESTURE CONTROL^{1,*} || BMW HEAD-UP DISPLAY^{1,3} || BMW CONNECTED DRIVE^{1,*} AND CONCIERGE SERVICE^{1,*}. **UNMISTAKABLY AESTHETIC INTERIOR DESIGN** LARGE PANORAMA GLASS ROOF¹ || AMBIENT LIGHT IN THE INTERIOR AND EXTERIOR WITH WELCOME LIGHT CARPET || UNIQUE DESIGN OPTIONS BY BMW INDIVIDUAL. **EXPERIENCE ITS ATHLETICISM, DISCOVER ITS AESTHETICS. THE BMW X4.**

¹ Available as optional equipment.

² Available exclusively and as standard for M40i and M40d.

³ The information in the BMW Head-Up Display is not fully visible when viewed through polarised sunglasses. Content shown will depend on the equipment options chosen. Further optional equipment is required to display specific items.

*The availability of some equipment features and functions depends on engine variants or additional options. The market and production availability may vary. You can find detailed information about terms, standard and optional equipment at www.bmw.com or from your BMW Partner. Some ConnectedDrive Services may differ between countries. Please consult your local BMW partner for more information.

MORE POWER FROM LESS FUEL.

More power from three to 12 cylinders. Consume less, experience more – the BMW TwinPower Turbo engines offer the greatest possible dynamic performance with the greatest possible efficiency thanks to the newest injection systems, variable output control and sophisticated turbocharger technology. Whether diesel or petrol, and no matter how many cylinders, the engines from the BMW EfficientDynamics engine family allow markedly more agile power delivery and outstanding responsiveness even at low rpm, while being fuel-efficient and low in emissions.

MORE DRIVING PLEASURE, LESS EMISSIONS.

BMW EfficientDynamics is a technology package that includes not only the drive, but rather the whole vehicle concept and intelligent energy management. Provided as standard in every BMW, a variety of innovative technologies contribute to continuously improving efficiency. Via engine efficiency measures, electrification, lightweight construction methods and optimised aerodynamics, BMW has managed to reduce the CO₂ emissions of its fleet significantly.

MORE DYNAMICS, LESS WEIGHT.

Lower weight with intelligent lightweight construction. Special consideration for every last detail – intelligent lightweight construction means that the optimal material is found and implemented for each part of the vehicle. With extremely light high-tech materials such as aluminium and carbon fibre, BMW EfficientLightweight is pursuing the goal of minimising vehicle weight. That leads to even more dynamic performance, increased stability and heightened safety and comfort.



AERODYNAMICS

With targeted measures focusing on aerodynamics, BMW has optimised the drag coefficient and efficiency as well as interior acoustics. Fuel consumption has also been reduced. The Active air stream kidney grille and the Air Curtain on the front wheels are targeted detailed measures to further reduce air resistance.

ACTIVE AIR STREAM KIDNEY GRILLE

The Active air stream kidney grille represents the cutting edge of aerodynamic performance. When a cooling airflow is not needed, it electronically closes the radiator grille with its air vents and thereby reduces the amount of air flowing into the engine bay. This optimises both the aerodynamics and consumption rates.

DRIVING EXPERIENCE CONTROL INCL. ADAPTIVE MODE

The Driving Experience Control offers the driver the choice between the standard COMFORT mode, ECO PRO Mode, geared towards efficiency, and SPORT mode, which enables even more dynamic driving. The new interactive function ADAPTIVE Mode* continuously adjusts the Dynamic Damper Control, the steering and the Steptronic transmission to suit the current driving situation.

IN THE BMW X4.

¹ Available as optional equipment.
² Only available for M40i and M40d.

³ Electronically limited.

⁴ This engine version is not available in all countries. Please contact your local BMW partner for more information.



ENGINE HIGHLIGHTS OF THE BMW X4.

M40i

BMW TwinPower Turbo 6-cylinder petrol engine with 265 kW (360 hp) and 500 Nm torque
Acceleration 0–100 km/h: 4.8 s
Top speed: 250 km/h³
Combined fuel consumption: –⁴ l/100 km
Combined CO₂ emissions: –⁴ g/km

xDrive20d

BMW TwinPower Turbo 4-cylinder diesel engine with 140 kW (190 hp) and 400 Nm torque
Acceleration 0–100 km/h: 8.0 s
Top speed: 213 km/h
Combined fuel consumption: –⁴ l/100 km
Combined CO₂ emissions: –⁴ g/km

WE KEEP OUR PROMISE: AS STANDARD, ALL BMW TWIN POWER TURBO ENGINES CONFORM TO THE EU6 STANDARD THANKS TO BMW EFFICIENT DYNAMICS.

The **8-speed Steptronic Sport transmission*** offers incredibly sporty gear changes. Whether automatic or manual using gearshift paddles or gear lever – for comfortable coasting or incredibly dynamic driving. In SPORT mode and with the gear lever in the left-hand S/M position, the gear shifts are configured for maximum performance.

The intelligent **BMW xDrive all-wheel** drive system smoothly and variably distributes drive power to the front and rear wheels for maximum traction, driving dynamics and safety in every driving situation. For even better agility, the electronically controlled power distribution for instance counterbalances oversteer or understeer on bends.

The **Adaptive M suspension^{1,2}** can be electronically adjusted at any time to suit the road and driving conditions. The driver can also adjust the suspension characteristics via the Driving Experience Control to enable their preferred driving style at the time – from comfortable to extremely athletic with markedly agile handling.

The **adaptive suspension^{1,*}** makes it possible to adjust the damper characteristics to suit any given driving situation, increasing comfort and driving dynamics. In addition to the standard COMFORT setting, for high driving comfort, there are two other programs available, SPORT and SPORT+², for an even sportier driving style.

Performance Control intervenes via engine control and through controlled braking of the drive wheels towards the inside of the bend. This distributes more drive power to the outer wheels. Directing the vehicle's angular momentum into the curve to boost agility and directional stability.

Dynamic Stability Control (DSC) permanently assesses the vehicle's movements and stabilises it using engine and braking regulation when unstable driving conditions are detected. Additional features of DSC are, for example, brake drying, braking readiness or the Hill-Start assistant, which holds the vehicle briefly in place when starting on inclines to prevent it from rolling backwards.

*The availability of some equipment features and functions depends on engine variants or additional options. The market and production availability may vary. You can find detailed information about terms, standard and optional equipment at www.bmw.com or from your BMW Partner.
The data for fuel consumption, CO₂ emissions and energy consumption are determined in accordance with the measurements processes as defined by European Regulation

(EU) 715/2007 in the applicable version. Data refer to a vehicle with base-level equipment in Germany, and the ranges account for differences according to the selected wheel and tyre size and the optional equipment. For these vehicles, values other than those specified here may apply for the assessment of taxes and other vehicle-related charges that are (also) based on CO₂ emissions. Version 01/18/2019

DRIVER ASSISTANCE.

BMW Personal CoPilot By your side, when you decide.



Driving Assistant Plus^{1,2,*} offers greater comfort and security during monotonous or complex driving situations. These can include traffic jams, stop-and-go traffic or long journeys through the city, on country roads or motorways, along with navigating junctions and lane changes.

The **Steering and lane control assistant incl. Traffic jam assistant^{1,*}** can be activated to support you in monotonous traffic situations. At speeds of up to 210 km/h on all road surfaces, the system conveniently supports steering and keeps the vehicle in the centre of its lane. Steering support is possible with or without Active cruise control.

When approaching crossroads with traffic lights, a give-way sign or a stop sign, the **Crossroads Warning^{1,*}** recognises any traffic signs and warns the driver with acoustic and visual signals. Additionally, the brakes are prepared, ensuring that maximum braking power is immediately available.

The **Lane Change Warning^{1,*}** assists the driver at speeds between 70 km/h to 210 km/h with convenient corrective steering interventions, helping to keep the vehicle in the lane and to actively avoid potential side impacts.

Evasion assist^{1,*} supports the driver with a targeted steering intervention at speeds of between 40 and 160 km/h when an obstacle must be avoided. Furthermore, the system helps the driver to keep the vehicle stable during the evasive manoeuvre.

Active cruise control¹ with Stop&Go function, Speed Limit Info including No-overtaking* indicator and Approach control warning with braking function reacts to stationary vehicles, independently maintains a preselected distance from the vehicle ahead and controls speed down to standstill, automatically accelerating again as soon as traffic flow allows it.

The equipment package **Parking Assistant Plus^{1,*}** makes parking and manoeuvring the vehicle easier. It features Surround View including Top View, Remote 3D View*, PDC as well as a lateral parking aid, the Active Park Distance Control (PDC), emergency braking function and the Parking Assistant with linear guidance that provides fully automatic parking both parallel and perpendicular to the road.

*The availability of some equipment features and functions depends on engine variants or additional options. The market and production availability may vary. You can find detailed information about terms, standard and optional equipment at www.bmw.com or from your BMW Partner.

¹ Available as optional equipment.
² Function may be limited in darkness, fog or bright glare.

SAFETY.

■ Standard equipment □ Optional equipment

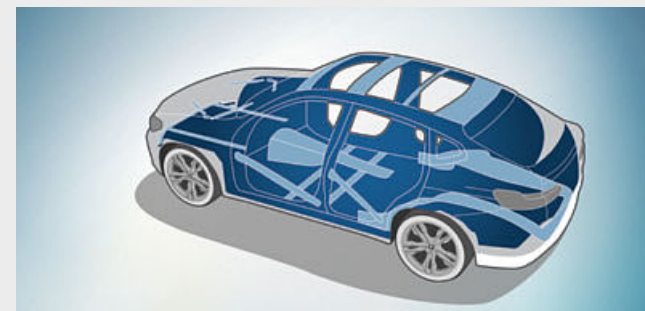

■ The functional structure of the **passenger cell** is composed of a specialised system of beams and nodal connections, featuring strategically deployed high-strength materials so as to deliver maximum passive safety in the event of front, side and rear collisions.

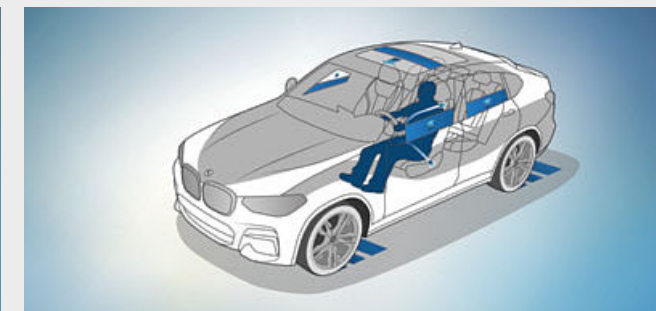

□ **Active Protection** is a preventive occupant protection system that pretensions the seat belts in critical situations, puts electric seats in an upright position and closes windows and the sunroof, if featured.

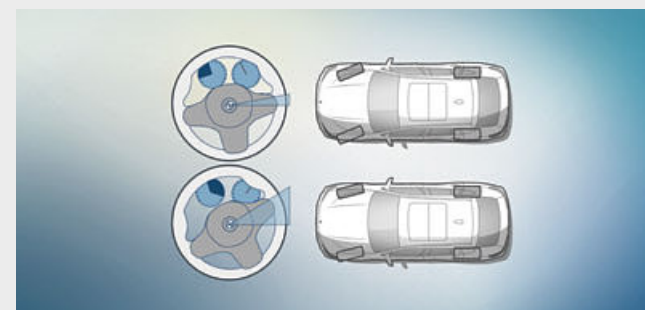

■ The **Variable sport steering** with Servotronic creates a direct and agile steering response and ensures that less physical effort is required to turn the wheel. It reacts to the angle of the steering wheel with varying steering ratios. This improves handling when driving more dynamically and reduces the effort needed to steer when parking and turning.

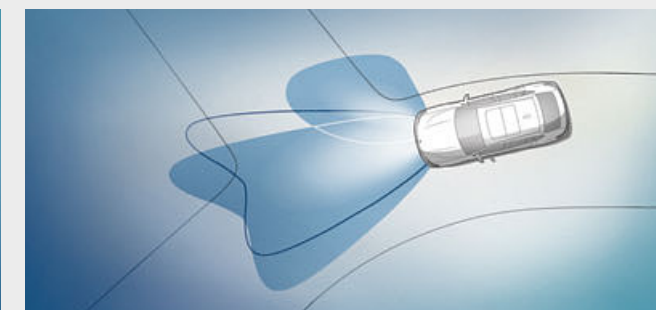

□ The **adaptive LED headlights** include low-beam and anti-dazzle high-beam headlights (BMW Selective Beam) and turn indicators with full LED technology. The equipment also features cornering lights, daytime running lights and Adaptive headlights with variable light control for excellent illumination of the road ahead and better visibility in the dark.

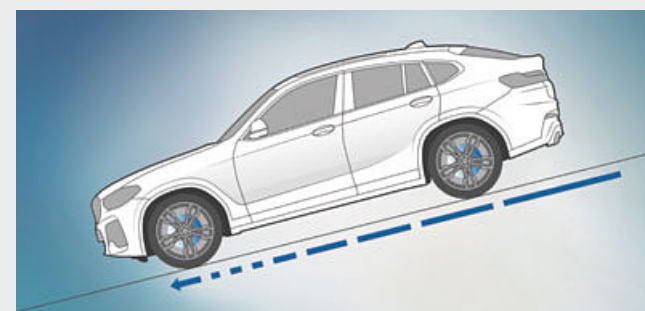

■ The optional **Hill Descent Control (HDC)** in the xDrive models is a system which, when activated, ensures that the vehicle can master the steepest downhill runs automatically and safely at just above walking pace, without the driver having to brake.

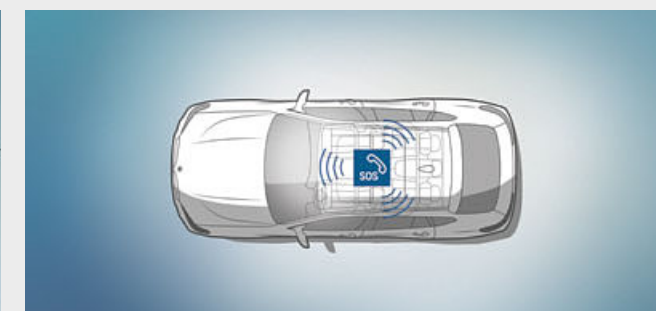

□ If there is an accident, time is of the essence. **Intelligent Emergency Call** gets help and can even save lives in case of an emergency. It contacts specially trained call centre agents in native language who offer support to you and your passengers until the emergency services arrive. The first responders also receive important information directly.

The Standard and Optional equipment may differ between countries. Please consult your local BMW partner for more information.

CONNECTIVITY AND INFOTAINMENT.

BMW ConnectedDrive So connected, you're free.

CONNECTED FOR OVER 20 YEARS.

Focused on the future – from the very beginning. By the 1990s, BMW had already made headway in connected mobility. Another milestone of the digital future was surpassed in 2004: vehicles with built-in SIM cards. Then came the first online functionality, Google Services and innovative display systems such as the BMW Head-Up Display. Throughout this process, the desires of the customer have always taken centre stage. In a first for a premium automobile manufacturer, BMW makes it possible to book and pay for services flexibly via the BMW ConnectedDrive Store, in the vehicle or on a computer at home. And with the introduction of BMW Connected, the Open Mobility Cloud and the BMW Intelligent Personal Assistant, BMW is taking the next steps into the future of mobility.

MORE THAN 20 SERVICES IN THE BMW CONNECTED DRIVE STORE.

ConnectedDrive open the gate to the digital world of BMW. Use vehicle apps such as news, weather, office or online search on the go and be well informed at all times. Via the ConnectedDrive Store or directly in your BMW, you can book additional digital services such as Connected Music or Concierge Service – anytime, anywhere, easily and flexibly.

IN TOUCH 24/7 WITH BMW CONNECTED.

Are the doors of my car really locked, when should I leave my office to arrive in time for dinner at the fancy Italian restaurant and how will I find my way there? As your personal mobility assistant, the BMW Connected App can easily help you with all these questions. It connects you directly with your car, giving you access before and during your trip to numerous functions, which make every drive simpler and more comfortable.



BMW CONNECTED+

Your BMW and smartphone merge to form a single unit with BMW Connected+. Use the personalised features of the BMW Connected app both inside and outside your car. Share journey information with friends, get directions right up to the door of your destination or control your smart home.*

WiFi HOTSPOT

Take part in video conference calls on your tablet or stream the final episode of your favourite series on your smartphone. The Wi-Fi Hotspot^{1,2} is a way to go online with LTE speed (if available) using the SIM card installed in your vehicle. You and your fellow passengers can surf the Web on up to ten devices.

CONCIERGE SERVICE

Will it be sunny tomorrow in Rome? When does my flight take off? The Concierge Service^{1,*} is there to help when you are travelling and can support you with any request at the touch of a button. Whether that is a booking at a restaurant, a hotel or a cinema. You can even use it for payments. Wherever you are, whatever you need, the Concierge Service is by your side.*

IN THE BMW X4.

¹ Available as optional equipment.

² The WiFi hotspot fulfils all in-vehicle requirements for use of the internet with the maximum LTE standard. Usage is subject to cost.

*The availability of some equipment features and functions depends on engine variants or additional options. The market and production availability may vary. You can find detailed information about terms, standard and optional equipment at www.bmw.com or from your BMW Partner.

COMFORT AND FUNCTIONALITY.



In warm weather, the **Active seat ventilation^{1,*}**, front provides a cool and pleasant seat temperature, resulting in a more comfortable driving experience. Air vents in the seat surfaces and backrests blow air through the perforated seat covers. The intensity of the airflow is selected from three available settings.

The **acoustic glazing¹** on the front side windows complements the acoustic glazing on the front windscreen and significantly reduces the level of noise for everyone inside the vehicle. It minimises noise created by the outside surroundings and flow of air, as well as by the engine, tyres and windscreen wipers. Music listeners and hands-free device users in particular will appreciate the difference this makes.

When open, the **Panorama glass roof¹** provides a great deal of fresh air. Closed, it creates a bright, light-flooded atmosphere in the interior. It opens and closes completely automatically at the push of a button or with the car key, and is equipped with slide and lift functions, roller sunblind and wind deflector.

The **Comfort access system¹** makes it possible to open all four vehicle doors, including the luggage compartment, without using the key. This equipment option includes contactless opening and closing of the tailgate with a quick wave of the foot under the rear bumper.

Ambient light, including Ambient contour lighting¹ in the front and rear doors, creates a relaxed, cosy lighting atmosphere in the interior. The **Welcome Light Carpet^{1,*}** illuminates the area in front of the car doors when entering and exiting. Six dimmable light designs in White, Blue, Orange, Bronze, Lilac and Green are available.

The **Storage compartment package¹** includes a hinged compartment in the front, nets on the back of the front seats, 12V sockets in the rear centre console incl. USB adapter and in the luggage compartment. The latter also contains hooks on the luggage compartment wall, a fastening strap, lashing rails on the luggage compartment floor and adjustable fastening points, a remote backrest unlocking and a cargo function for expanding the luggage compartment volume.

Some ConnectedDrive Services may differ between countries. Please consult your local BMW partner for more information.

BASE MODEL.

Discover even more with the new BMW brochures app. Available now, for your smartphone and tablet.



■ The slim-line modelled instrument panel provides a distinctly noticeable command position that gives optimal overview of the action at all times. The interior trim finishers in Oxide Silver dark matt with highlight trim finishers Pearl Chrome provide visual highlights.

□ At first glance, the ergonomically perfectly designed driving experience area shows BMW's typical orientation towards the driver. The standard seats have multiple manual adjustment options, ensuring a particularly good seating position and optimum lateral support. Finished as standard in Cloth 'Hevelius' Anthracite and interior colour black with many optional choices such as the high-quality leather 'Vernasca' or BMW Individual extended leather trim 'Merino'.

Selected base model equipment features:

- 18" light alloy wheels V-spoke style 618
- LED headlights
- Sport leather steering wheel
- 1-zone automatic air conditioning
- BMW Live Cockpit with 8.8" touchscreen
- Driving Experience Control
- M Sport suspension
- Variable sport steering
- Performance Control
- Cruise Control with braking function
- Park Distance Control (PDC), rear



□ 18" light alloy wheels Double-spoke style 688 Reflex Silver, wheel size 7J x 18 with 225/60 R18 tyres.



□ 19" light alloy wheels V-spoke style 691 in Reflex Silver, wheel size 7.5J x 19 with 245/50 R19 tyres.

xLINE.

Equipment 24 | 25

■ Standard equipment □ Optional equipment

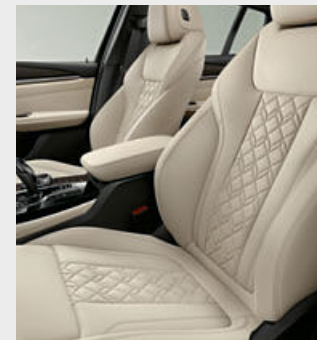

■ 19" light alloy wheels Y-spoke style 694, Ferric Grey, wheel size 7.5J x 19 with 245/50 R19 tyres.



□ 20" light alloy wheels Y-spoke style 695 Orbit Grey bright turned with mixed tyres, front 8J x 20 with 245/45 R20 tyres, rear 9.5J x 20 with 275/40 R20 tyres.

□ The combination of the Sport leather steering wheel with the optional fine-wood trim 'Fineline' Cove highlight trim finisher in Pearl Chrome has a sporty and elegant effect.

□ Sport seats with pronounced side bolsters in BMW Individual extended 'Merino' leather Ivory White lend the interior a highly elegant look.

xLine exterior equipment:

- BMW kidney grille with seven exclusively designed vertical slats with front sides in Aluminium matt, grille frame in Chrome
- 19" light alloy wheels Y-spoke style 694 in Ferric Grey; other wheels available
- Air Breather in Pearl Chrome
- Side window surrounds, window guides and window recess finisher in Aluminium satinised, mirror foot, B-pillar and C-pillar in Black high-gloss
- Side skirt trim in Aluminium matt
- Underbody protection front and rear in Aluminium matt

xLine interior equipment:

- Door sill finishers in Aluminium with "BMW xLine" lettering
- Sport seats for driver and front passenger in Cloth/leather combination 'Vivus' Anthracite with contrast stitching; other upholsteries available
- Car key with Chrome high-gloss detailing
- Interior trim finishers in Black high-gloss with accent in Pearl Chrome; other trims available

M SPORT PACKAGE.

powered by 



■ High-quality and high-grip M leather steering wheel with multifunction buttons.

□ The multi-adjustable M Sport seats with bucket seat character and partly integrated headrest provide a maximum sporty look and excellent lateral support for you and your front passenger.

■ 19" M light alloy wheels Double-spoke style 698 M in Bicolour Ferric Grey, bright turned, wheel size 7.5J x 19 with 245/50 R19 tyres.

□ 20" M light alloy wheels Double-spoke style 699 M in Bicolor Orbit Grey, bright turned, with mixed tyres, front 8J x 20 with 245/45 R20 tyres, rear 9.5J x 20 with 275/40 R20 tyres.

M Sport package exterior equipment:

- M Aerodynamics package with front apron, side skirts and wheel arch trims in body colour
- LED fog lights
- 19" M light alloy wheels Double-spoke style 698 M in Bicolor Ferric Grey gloss-lathed with run-flat properties; other wheels available
- M Sport suspension
- BMW Individual high-gloss Shadow Line, alternatively BMW Individual Exterior Line Aluminium satinised
- M designation on the sides
- Exterior mirror caps in body colour
- M Sport brake
- Rear apron with diffuser insert in Dark Shadow metallic
- Tailpipe trim strip in high-gloss Chrome
- Exclusive paintwork in Carbon Black metallic; other paintworks available

M Sport package interior equipment:

- M door sill finishers, M driver footrest and M specific pedals
- Sport seats for driver and front passenger in Cloth/leather combination "Vernasca" Black with contrast stitching in blue or red, alternatively
- Sport seats for driver and front passenger in Exclusive leather "Vernasca" Black with contrast stitching in blue or red featuring instrument panel in Sensatec with blue or red stitching; other upholsteries available
- M Leather steering wheel with Multifunction
- BMW Individual headliner anthracite
- Interior trim finishers in Aluminium Rhombic with highlight trim finishers in Pearl Chrome, other trims available
- Car key with exclusive M designation
- M specific floor mats in velour
- Loading sill of the luggage compartment in stainless steel

M SPORT X PACKAGE.

powered by 

Equipment 26 | 27

■ Standard equipment □ Optional equipment

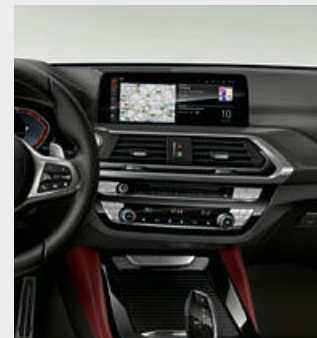

■ The interior trim finishers Aluminium Rhombic dark with highlight trim finishers Pearl Chrome are exclusively available for the M Sport X package and further emphasise the sporty, distinctive interior design.

□ The Sport seats in optional leather "Vernasca" Tacora red with contrast stitching in basalt grey provide a high-quality ambience and high seating comfort even during long journeys.

■ 19" M light alloy wheels Double-spoke style 698 M in Bicolour Ferric Grey, bright turned, wheel size 7.5J x 19 with 245/50 R19 tyres.

□ 20" M light alloy wheels Double-spoke style 787 M in Bicolor Orbit Grey, bright turned, with mixed tyres, front 8J x 20 with 245/45 R20 tyres, rear 9.5J x 20 with 275/40 R20 tyres.

M Sport X package exterior equipment:

- M Sport X exterior package with side skirts, wheel arch trim and rear apron with diffuser insert in Frozen Grey
- M Aerodynamics package with front apron in body colour
- LED fog lights
- 19" M light alloy wheels Double-spoke style 698 M in Bicolor Ferric Grey gloss-lathed with run-flat properties; other wheels available
- M Sport suspension
- BMW Individual high-gloss Shadow Line
- M designation on the sides
- Exterior mirror caps in body colour
- M Sport brake
- Tailpipe trim strip in high-gloss Chrome
- Exclusive paintwork in Carbon Black metallic; other paintworks available

M Sport X package interior equipment:

- M door sill finishers, M driver footrest and M specific pedals
- Sport seats for driver and front passenger in Cloth/leather combination "Vernasca" Black with contrast stitching in blue or red, alternatively
- Sport seats for driver and front passenger in Exclusive leather "Vernasca" Black with contrast stitching in blue or red featuring instrument panel in Sensatec with blue or red stitching; other upholsteries available
- M Leather steering wheel with Multifunction
- BMW Individual headliner anthracite
- Exclusive interior trim finishers in Aluminium Dark Rhombic with highlight trim finishers in Pearl Chrome, other trims available
- Car key with exclusive M designation
- M specific floor mats in velour
- Loading sill of the luggage compartment in stainless steel

BMW M.

The BMW X4 M40i and BMW X4 M40d.

The **BMW X4 M40i** and **BMW X4 M40d** offer outstanding precision and agility. The dynamic lateral and longitudinal characteristics are increased, and intensive driving pleasure assured, thanks to the comprehensive new calibration of the suspension, the M Performance-specific calibration of the variable sport steering, the standard M Sport brake and a BMW xDrive all-wheel drive system with emphasis on the rear wheels incl. M Sport differential.



The 8-speed Steptronic Sport transmission offers incredibly sporty gear changes. Whether automatic or manual using gearshift paddles or gear lever – for comfortable coasting or incredibly dynamic driving. In SPORT mode and with the gear lever in the left-hand S/M position, the gear shifts are configured for maximum performance.



Also no compromise inside: the M leather steering wheel with shift paddles and the M-specific pedals combine sporting form and function.



The aluminium front doorsill finishers welcome the driver and front passenger with the "M40i" high-quality model designation.



The M Aerodynamics package underscores the vehicle's imposing athleticism and optimizes its airflow. The front and rear feature distinctive bumpers in body colour. The special side skirts are also finished in body colour and emphasise the athletic appearance. The colour-contrasting rear diffuser insert in Dark Shadow metallic is an eye-catching feature on the rear.

BMW INDIVIDUAL.

THE EXPRESSION OF PERSONALITY.



A declaration of love for light: the BMW Individual Sunstone metallic paintwork gives the new BMW X4 a dazzling appearance with special effect pigments, which, depending on the incidence of light, further intensifies and leaves a lasting impression.



Made of immaculate, particularly voluminous leather, the BMW Individual extended leather trim 'Merino' Ivory White spreads an ambience that radiates luxury, sportiness and an absolute sense of extraordinary design.



Unique right from the start: The BMW Individual door sill finisher marks an exclusive territory characterised by an absolute sense of the extraordinary and the special.

If someone decides, then you: BMW Individual offers you all the options to customise the BMW X4 according to your wishes, with the degree of customisation entirely up to you. Add your personal driving experience to the typical BMW driving pleasure. Choose what suits you the most from particularly high-quality equipment options: Exclusive BMW Individual paint finishes that show style and confidence. Soft, voluminous leather trims and interior trim finishers made of fine woods, which turn the interior into your personal comfort zone. Or go your very own way, only following your ideas – BMW Individual ensures that they become an automotive reality.

ADDITIONAL EQUIPMENT.

Discover even more with the new BMW brochures app. Available now, for your smartphone and tablet.

■ Standard equipment □ Optional equipment



□ When open, the Panorama glass roof provides a great deal of fresh air. Closed, it creates a bright, light-flooded atmosphere in the interior. It opens and closes completely automatically at the push of a button or with the car key, and is equipped with slide and lift functions, roller sunblind and wind deflector.

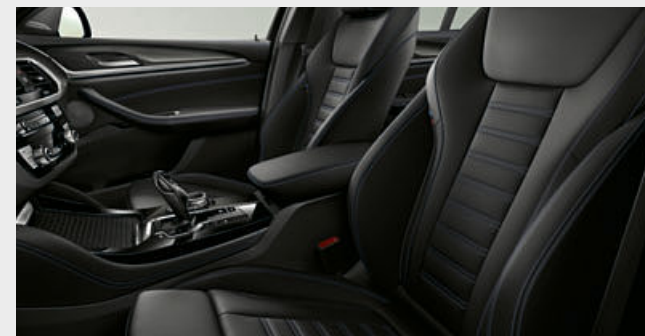

□ The individually adjustable Sport seats for the driver and front passenger feature numerous manual adjustment options, including backrest width, fore-and-aft position, and the backrest and seat angle. Thanks to taller seat and backrest bolsters, and well-defined side bolsters, they provide excellent ergonomics and a high degree of lateral support.



□ The BMW Individual extended leather trim 'Merino' in Ivory White impresses with the outstanding quality of the hide, as well as with masterfully crafted details.



■ The slight tinted heat/sun protection glazing reflects infrared radiation to prevent the interior from heating up.

□ The acoustic glazing on the front side windows complements the acoustic glazing on the front windscreen and reduces the level of noise for everyone inside the vehicle.



□ In warm weather, the Active seat ventilation*, front provides a cool and pleasant seat temperature, resulting in a more comfortable driving experience.



□ The full-colour BMW Head-Up Display¹ projects all information relevant to the journey directly into the driver's field of vision.



□ Exclusive galvanic embellishers for controls such as the Start/Stop button, along with volume and temperature dials, lend a particularly high-quality look.



□ The Instrument panel and door panels in Sensatec lend the interior of the vehicle a highly exclusive atmosphere.



□ Harman Kardon surround sound system* with 600 watt digital amplifier, vehicle-specific equalising and loudspeakers with chrome detailing.



□ Remote backrest unlocking* for the rear seats allows the rear seat backrests to be unlocked and folded down conveniently via a lever in the luggage compartment.



□ The Roof rails in Aluminium satinated provide the base for a multifunctional BMW roof rack unit.



□ The Trailer tow hitch with electrically adjustable tow ball and trailer stability control is approved for heavy loads of up to 2,400 kg.



■ The rear lights with lighting elements in LED technology consist of individual high-performance LED lighting elements and have the characteristic, striking BMW L-shape, meaning that the vehicle is clearly recognisable as a BMW even in the dark.



□ The 8-speed Steptronic Sport transmission* offers incredibly sporty gear changes. Whether automatic or manual using gearshift paddles or gear lever.



■ The Storage options, including the storage compartment, encompass several storage spaces, including bottle holders and cupholders.

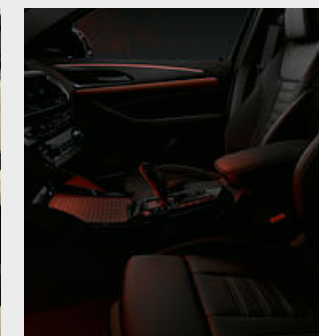

□ Ambient light creates a relaxed lighting atmosphere, including ambient light accents and the Welcome Light Carpet.

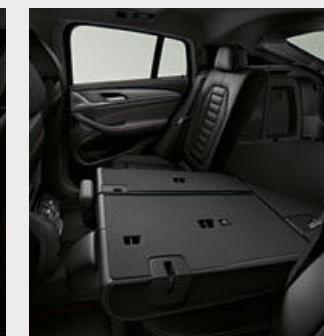

■ The Through-loading system with rear seat backrests, which are divisible in a 40:20:40 ratio, guarantees flexibility when transporting people and objects.

¹ The information in the BMW Head-Up Display is not fully visible when viewed through polarised sunglasses. Content shown will depend on the equipment options chosen. Further optional equipment is required to display specific items.

*The availability of some equipment features and functions depends on engine variants or additional options. The market and production availability may vary. You can find detailed information about terms, standard and optional equipment at www.bmw.com or from your BMW Partner.

The Standard and Optional equipment may differ between countries. Please consult your local BMW partner for more information.

ADDITIONAL EQUIPMENT.

Discover even more with the new BMW brochures app. Available now, for your smartphone and tablet.

■ Standard equipment □ Optional equipment

□ With BMW Gesture Control*, certain functions can be operated by means of defined hand movements. For certain operations the system will for example recognise gestures such as 'swiping' or 'pointing' for accepting or rejecting an incoming call, or circular motions of the index finger to adjust volume.

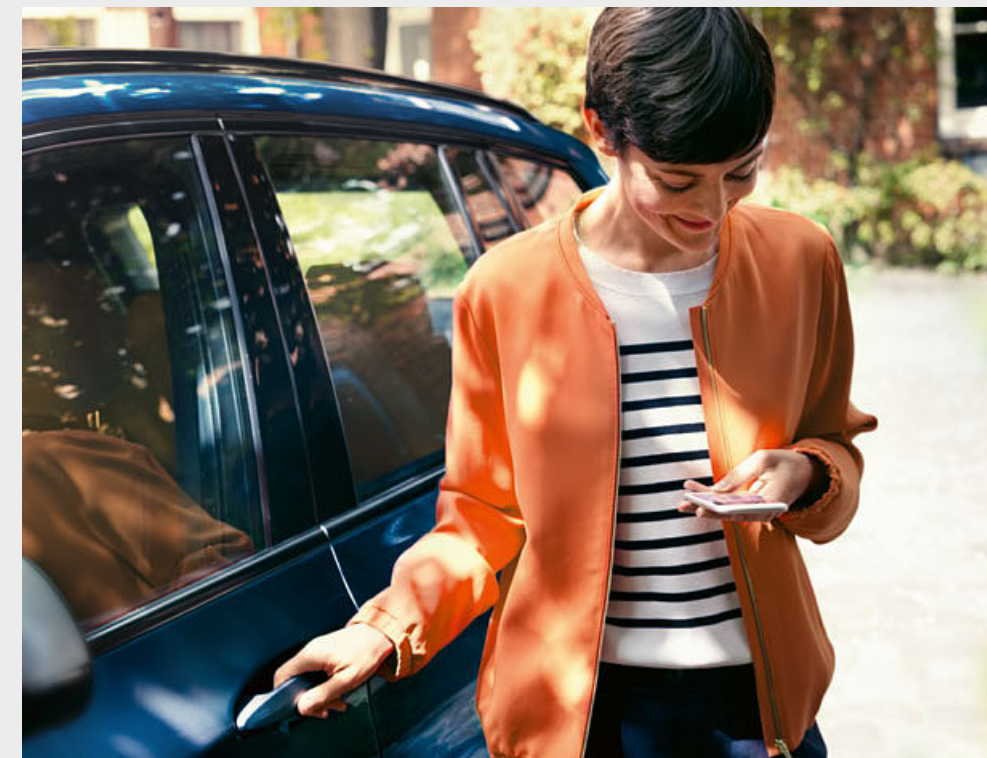

□ Maximum personalisation, seamless synchronisation and easy operation. BMW Connected+* makes your BMW and smartphone an unbeatable team.

□ Is the parking facility your final destination? Not likely. Navigate Door to Door* guides you as you walk to where you need to be and then to find your way back to your BMW.



□ The BMW Live Cockpit Professional with navigation function includes two high-quality displays consisting of a high-resolution 10.25" Control Display that can be operated by touch and a fully digital 12.3" instrument display. The BMW Operating System 7.0 can also be operated via the iDrive Touch Controller.



□ Telephony with wireless charging¹ offers a comprehensive telephony package with Bluetooth connectivity and the technical capacity for a WiFi hotspot.

□ Get online quickly. The Wi-Fi Hotspot² allows you to use the Internet in your car with LTE speed (if available) on up to ten devices.

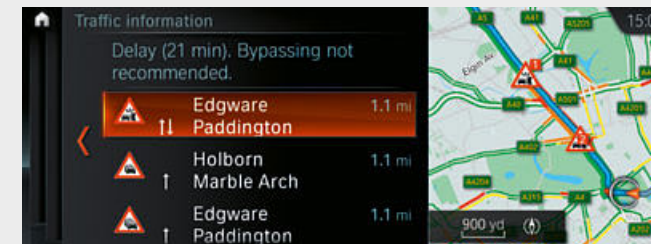

□ Why waste time in traffic jams? Real Time Traffic Information* lets you reach your destination faster and more effectively. It monitors the current traffic situation virtually in real-time and calculates alternative routes. The local hazard warning system* is an additional feature that alerts you to adverse road conditions or accidents.

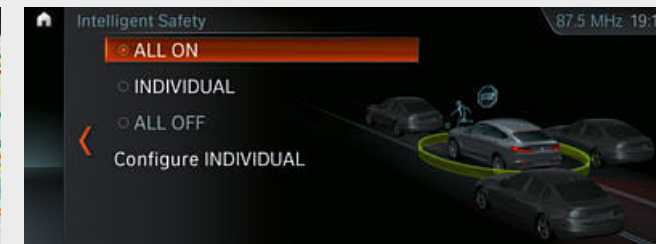

□ Driving Assistant Plus³* offers greater comfort and security during monotonous or complex driving situations. These can include traffic jams, stop-and-go traffic or long journeys through the city, on country roads or motorways, along with navigating junctions and lane changes.



□ The Ambient Air Package comprises a fragrance dispersal function and an air ionisation function. There are eight fragrances to choose from, all specially composed for the vehicle.

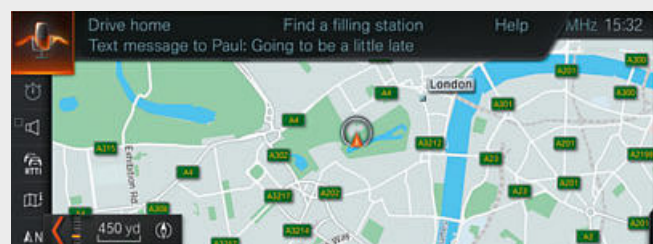

□ 'Take me to the nearest gas station,' 'I want to call my lawyer.' Or 'Play a song by the Rolling Stones.' With natural voice commands, you can control many features of your vehicle thanks to Online Speech Processing*. Dictate emails or find special points of interest simply by saying them out loud.*

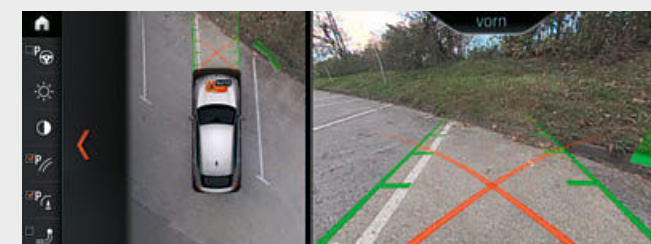

■ The equipment package Parking Assistant Plus* makes parking and manoeuvring the vehicle easier. It features Surround View including Top View, Remote 3D View*, PDC as well as a lateral parking aid, the Active Park Distance Control (PDC), emergency braking function and the Parking Assistant with linear guidance that provides fully automatic parking both parallel and perpendicular to the road.



□ Surround View* includes the camera-based functions Rear view camera, Top View, Panorama View, 3D View and Remote 3D View*. The cameras in the exterior mirrors as well as at the front and rear allow for a 360° all-around view. The Panorama View makes approaching intersections and exiting driveways safer. It shows the traffic to the right and left of the car on the Control Display.

¹ Supports inductive charging for Qi-compatible mobile phones. Special charging cases are available from Original BMW Accessories for selected smartphones that do not support the Qi standard for inductive charging.

² The WiFi hotspot fulfils all in-vehicle requirements for use of the internet with the maximum LTE standard. Usage is subject to cost.

³ Function may be limited in darkness, fog or bright glare.

* The availability of some equipment features and functions depends on engine variants or additional options. The market and production availability may vary. You can find detailed information about terms, standard and optional equipment at www.bmw.com or from your BMW Partner.

The Standard and Optional equipment may differ between countries. Please consult your local BMW partner for more information.

Some ConnectedDrive Services may differ between countries. Please consult your local BMW partner for more information.

EXTERIOR COLOURS.

Discover even more with the new BMW brochures app. Available now, for your smartphone and tablet.

■ Standard equipment □ Optional equipment



■ Non-metallic 668 Black



□ Non-metallic 300 Alpine White¹

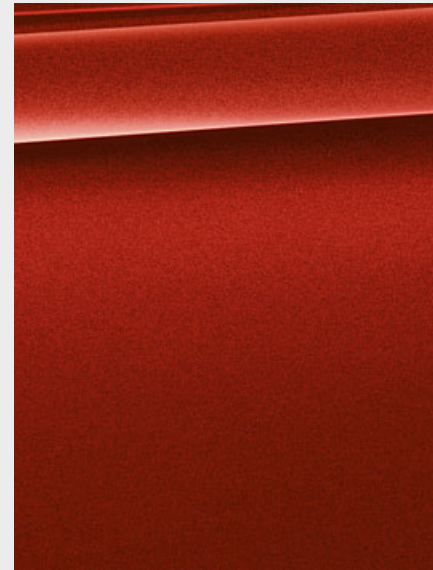

□ Metallic C06 Flamenco Red Brilliant Effect²



□ Metallic A96 Mineral White

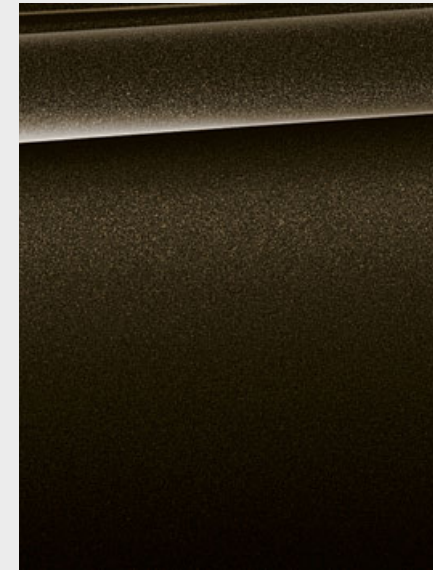

□ Metallic C07 Sparkling Storm Brilliant Effect

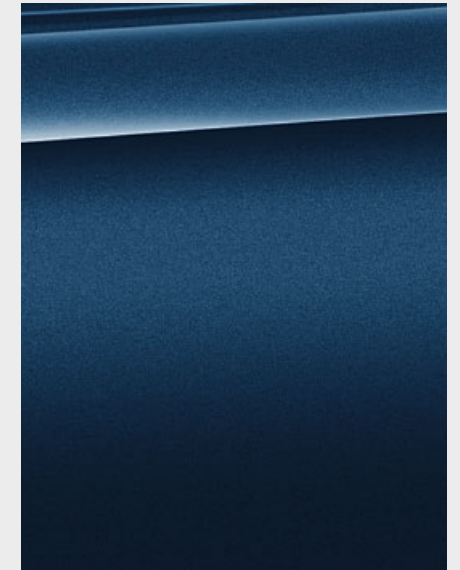

□ Metallic C1M Phytionic blue²

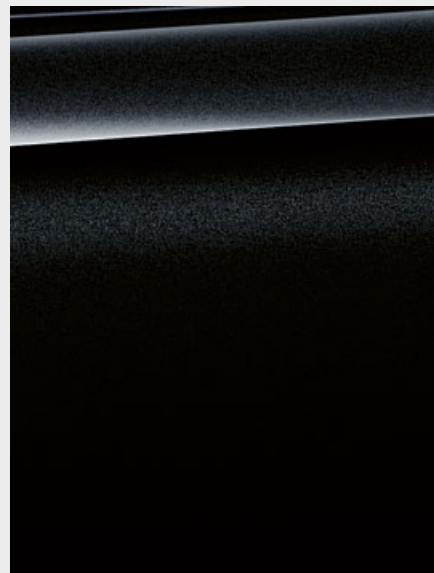

□ Metallic 475 Black Sapphire²



□ Metallic A83 Glacier Silver²

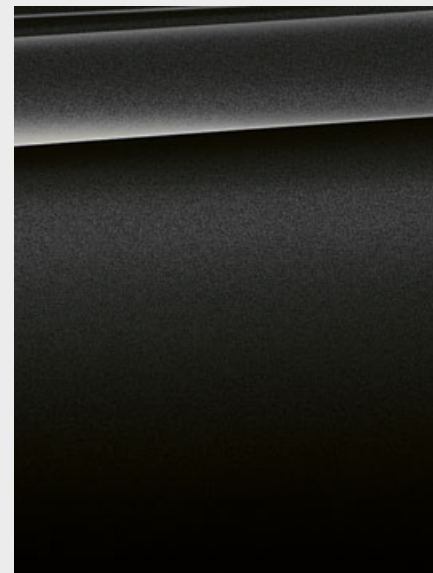

□ Metallic A90 Sophisto Grey Brilliant Effect²

M SPORT PACKAGE M SPORT X PACKAGE

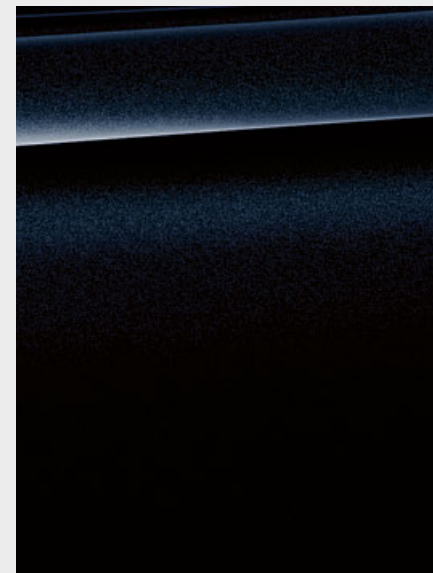

□ Metallic 416 Carbon Black³

BMW INDIVIDUAL.

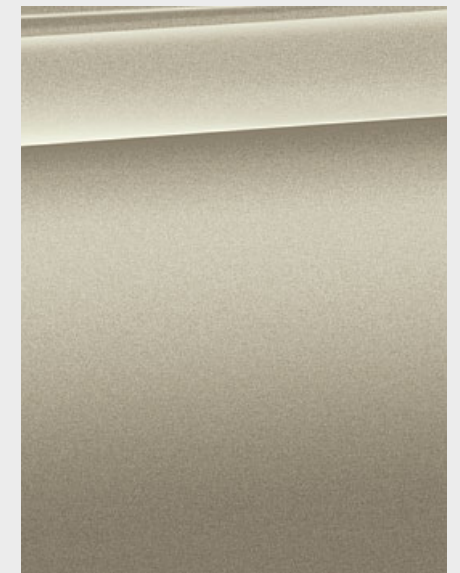

□ BMW Individual C1N Sunstone metallic²

[Colours] The colours printed above are intended to provide you with a first impression of paints and materials available for your BMW. Experience has shown, however, that printed images of paint, upholstery and interior trim colours cannot faithfully reproduce the ac-

tual appearance of the originals. We recommend therefore that you consult your BMW partner who will be able to show you original samples and assist with special requests.

¹ Available as standard for M Sport package and M Sport X package.

² Also optionally available for M Sport package and M Sport X package.

³ Exclusively available in conjunction with M Sport package and M Sport X package.

The Standard and Optional equipment may differ between countries. Please consult your local BMW partner for more information.

Discover even more with the new BMW brochures app. Available now, for your smartphone and tablet.

■ Standard equipment □ Optional equipment

CLOTH

Available with



■ Base

Cloth 'Hevelius' ECHAT Anthracite, interior colour Black

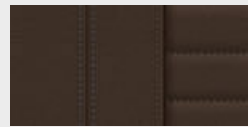

□ Base
□ xLine
□ M Sport package
□ M Sport X package

Leather 'Vernasca' MAMU Mocha with decorative stitching, interior colour Black.*

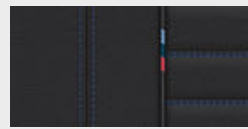

□ M Sport package
□ M Sport X package

Leather 'Vernasca' MANL Black, contrast stitching Blue, interior colour Black.*

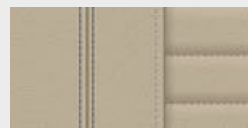

□ xLine
□ M Sport package
□ M Sport X package

Leather 'Vernasca' MAOQ Oyster with decorative stitching and extended features, interior colour Black.

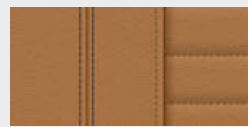

□ xLine
□ M Sport package
□ M Sport X package

Leather 'Vernasca' MAPQ Cognac with decorative stitching, interior colour Black.

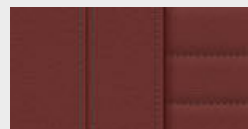

□ xLine
□ M Sport package
□ M Sport X package

Leather 'Vernasca' MAG6 Tacora Red with decorative stitching, interior colour Black.

CLOTH/LEATHER COMBINATION

Available with



□ Base
■ xLine

Cloth/leather combination 'Vivus' BVAT Anthracite, interior colour Black*

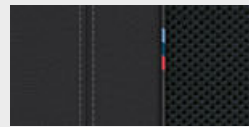

■ M Sport package
■ M Sport X package

Cloth/leather combination 'Vernasca' BWNL Black, contrast stitching Blue, interior colour Black

LEATHER

Available with



□ Base
□ xLine
□ M Sport package
□ M Sport X package

Leather 'Vernasca' MAFO Canberra Beige with decorative stitching, interior colour Black.*

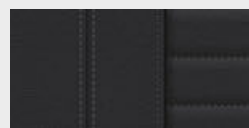

□ Base
□ xLine
□ M Sport package
□ M Sport X package

Leather 'Vernasca' MAH7 Black with decorative stitching, interior colour Black.*

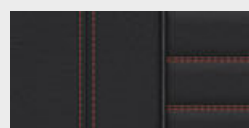

□ M Sport package
□ M Sport X package

Leather 'Vernasca' MAH8 Black, contrast stitching Red, interior colour Black*

BMW INDIVIDUAL LEATHER

Available with



□ Base
□ xLine
□ M Sport package
□ M Sport X package

BMW Individual extended leather trim 'Merino' leather VATQ Tartufo.*

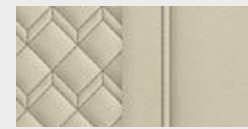

□ Base
□ xLine
□ M Sport package
□ M Sport X package

BMW Individual extended leather trim 'Merino' leather VAEW Ivory White.*

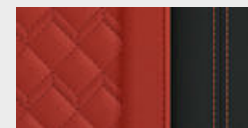

□ Base
□ xLine
□ M Sport package
□ M Sport X package

BMW Individual extended leather trim 'Merino' leather VAHZ Fiona Red/Black.*



□ Base
□ xLine
□ M Sport package
□ M Sport X package

4K9 Aluminium fine cutting with highlight trim finisher Pearl Chrome

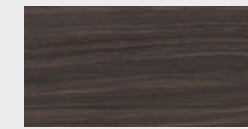

□ Base
□ xLine
□ M Sport package
□ M Sport X package

4LH Fine-wood trim 'Fineline' Cove with highlight trim finisher Pearl Chrome



□ Base
□ xLine
□ M Sport package
□ M Sport X package

4LQ Fine-wood trim poplar grain grey with highlight trim finisher Pearl Chrome

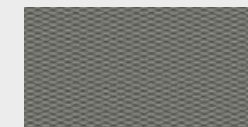

■ M Sport X package

4KN Interior trim finishes Aluminium Rhombicle dark with highlight trim finisher Pearl Chrome



□ M Sport package
□ M Sport X package

Interior trim finishes 'Carbon Fibre' on the instrument panel, doors and centre console with highlight trim finisher Pearl Chrome.

INTERIOR TRIM FINISHERS

Available with



■ Base

4K8 Oxide Silver dark matt with Pearl-Gloss Chrome accent lines

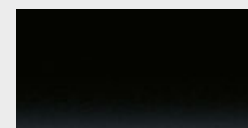

□ Base
■ xLine

4LU Black high-gloss, highlight trim finisher Pearl Chrome

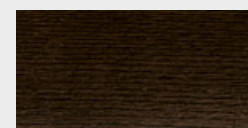

□ Base
□ xLine
□ M Sport package
□ M Sport X package

4K1 Fine-wood trim Oak dark high-gloss with highlight trim finisher Pearl Chrome



■ M Sportpaket

4K7 Aluminium Rhombicle with highlight trim finisher Pearl Chrome

BMW INDIVIDUAL INTERIOR TRIM FINISHERS

Available with



□ Base
□ xLine
□ M Sport package
□ M Sport X package

BMW Individual interior trim finishes 4ML piano finish Black*

BMW INDIVIDUAL HEADLINER

Available with

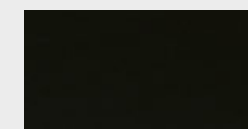

□ Base
□ xLine
□ M Sport package
□ M Sport X package

BMW Individual headliner 775 Anthracite

Please note that even normal long- or short-term use can lead to unrecoverable upholstery damage. This can be caused in particular by non-colourfast clothing.

Please note that the interior colour depends on the selected upholstery colour.

The availability of some equipment features and functions depends on engine variants or additional options. The market and production availability may vary. You can find detailed information about terms, standard and optional equipment at www.bmw.com or from your BMW Partner.

The Standard and Optional equipment may differ between the countries. Please contact your local BMW partner for more information.

WHEELS AND TYRES.

Discover even more with the new BMW brochures app. Available now, for your smartphone and tablet.



□ 21" M light alloy wheels Double-spoke style 718 M in Bicolor Cerium Grey matt, bright turned, with mixed tyres and run-flat properties, front 8.5J x 21 with 245/40 R21 tyres, rear 9.5J x 21 with 275/35 R21 tyres.⁶



□ 21" BMW Individual light alloy wheels V-spoke style 726 I in Bicolor Orbit Grey, bright turned, with mixed tyres and run-flat properties, front 8.5J x 21 with 245/40 R21 tyres, rear 9.5J x 21 with 275/35 R21 tyres.



□ 20" light alloy wheels Y-spoke style 695 Orbit Grey bright turned with mixed tyres, front 8J x 20 with 245/45 R20 tyres, rear 9.5J x 20 with 275/40 R20 tyres.



□ 20" M light alloy wheels Double-spoke style 699 M in Bicolor Orbit Grey, bright turned, with mixed tyres, front 8J x 20 with 245/45 R20 tyres, rear 9.5J x 20 with 275/40 R20 tyres.^{1,2}



□ 20" M light alloy wheels Double-spoke style 787 M in Bicolor Orbit Grey, bright turned, with mixed tyres, front 8J x 20 with 245/45 R20 tyres, rear 9.5J x 20 with 275/40 R20 tyres.³

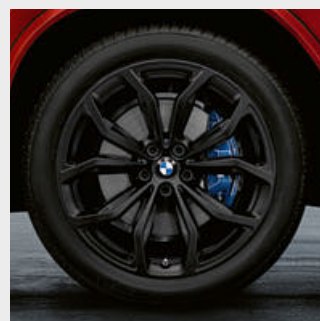

○ High-quality 20" BMW light alloy wheels Y-spoke style 695 in matt Jet Black. TPMS summer complete wheel set with run-flat mixed tyres.



□ 19" light alloy wheels V-spoke style 691 in Reflex Silver, wheel size 7.5J x 19 with 245/50 R19 tyres.



□ 19" light alloy wheels V-spoke style 692 in Bicolor Ferric Grey, bright turned, wheel size 7.5J x 19 with 245/50 R19 tyres.



■ 19" light alloy wheels Y-spoke style 694, Ferric Grey, wheel size 7.5J x 19 with 245/50 R19 tyres.⁴



■ 19" M light alloy wheels Double-spoke style 698 M in Bicolour Ferric Grey, bright turned, wheel size 7.5J x 19 with 245/50 R19 tyres.⁵



□ 18" light alloy wheels Double-spoke style 688 Reflex Silver, wheel size 7J x 18 with 225/60 R18 tyres.⁷



□ 18" light alloy wheels turbine styling 689 in Bicolor Jet Black non-metallic, bright turned, BMW EfficientDynamics, wheel size 7J x 18, with 225/60 R18 tyres.⁷

¹ Only available in conjunction with M Sport package.
² Runflat tyres standard for M40i and M40d.

³ Only available in conjunction with M Sport X package.

⁴ Only available in conjunction with xLine.

⁵ Only available in conjunction with M Sport package and M Sport X package.

⁶ Exclusively for M40i and M40d.

⁷ Standard for xLine.

The Standard and Optional equipment may differ between countries. Please consult your local BMW partner for more information.

GENUINE BMW ACCESSORIES.

■ Standard equipment □ Optional equipment ○ Accessories



○ This contemporary roof box in Black with titanium silver side trims has a 420-litre capacity and fits all BMW roof rack systems. It can be opened from both sides and features triple central locking on each side which makes it easy to load and provides anti-theft locking.



○ The BMW Advanced Car Eye 2.0 is a highly sensitive full-HD camera that captures events in front of and behind the car, even when it is parked. In the event of disturbances and extraordinary movement outside the vehicle, the camera automatically records the situation in order to document possible accidents or (attempted) break-ins.



○ The perfectly fitted, durable all-weather floor mats with raised border and elegant design protect the front and rear footwell from moisture and dirt. They are black and feature a black X4 inlay.



○ The BMW wireless charging cover enables inductive charging of the Apple iPhone™ 7 Plus. The innovative mobile phone case is compatible with all Qi-certified charging devices and also protects the phone.



○ The high-quality 21" M Performance forged wheels Y-spoke style 701 M are forged, Bicolor matt Jet Black, bright turned, weight-optimised and feature the M logo. Summer complete wheel set with run-flat mixed tyres, wheel size 8.5J x 21 with tyre size 245/40 R21 100Y XL RSC at the front and 9.5J x 21 with tyre size 275/35 R21 103Y XL RSC at the rear.

Discover the wide range of innovative solutions available for the exterior and interior, communication and information, and for transportation and the luggage compartment.

Your BMW Partner is on hand to advise you on the whole range of Original BMW Accessories. For more information, visit www.bmw.com

BMW X4		xDrive20i	xDrive30i	M40i	xDrive20d	xDrive30d	M40d
Weight							
Unladen weight EU ¹	kg	1805	1825	1940	1845	1895	1970
Maximum permissible weight	kg	2400	2400	2430	2410	2460	2525
Permitted load	kg	670	650	565	640	640	630
Permitted trailer load, unbraked ³	kg	750	750	750	750	750	750
Permitted trailer load, braked, max. 12% gradient/max. 8% gradient ³	kg	2400/2400 ²	2400/2400 ²	2400/2400 ²	2400/2400 ²	2400/2400 ²	2400/2400 ²
Luggage capacity	l	525–1430	525–1430	525–1430	525–1430	525–1430	525–1430
Engine⁵							
Cylinders/valves		4/4	4/4	6/4	4/4	6/4	6/4
Capacity	cm ³	1998	1998	2998	1995	2993	2993
Max. output/engine speed	kW (hp)/rpm	135 (184)/5000–6000	185 (252)/5200–6500	265 (360)/5200–6500	140 (190)/4000	195 (265)/4000	240 (326)/4400
Max. torque/engine speed	Nm/rpm	300/1350–4000	350/1450–4800	500/1850–5000	400/1750–2500	620/2000–2500	680/1750–2750
Drivetrain							
Type of drive		All-wheel	All-wheel	All-wheel	All-wheel	All-wheel	All-wheel
Standard transmission		8-speed Steptronic transmission	8-speed Steptronic transmission	8-speed Steptronic Sport transmission	8-speed Steptronic transmission	8-speed Steptronic transmission	8-speed Steptronic Sport transmission
Performance							
Top speed	km/h	215	240	250 ⁴	213	240	250 ⁴
Acceleration 0–100 km/h	s	8.3	6.4	4.8	8.0	5.8	4.9
Consumption⁶ – All engines conform to the EU6 standard							
Combined	l/100 km	7.9–8.9	7.9–8.9	– ⁸	– ⁸	6.9–7.8	7.1–7.9
Exhaust emissions standard (type-certified)		EU6d-temp	EU6d-temp	– ⁷	EU6d-temp	EU6d-temp	EU6d-temp
Combined CO ₂ emissions	g/km	177–200	178–201	– ⁸	– ⁸	180–203	184–204
Tank capacity, approx.	l	65	65	65	68	68	68
Wheels/tyres							
Tyre dimensions		225/60 R18 W	225/60 R18 W	245/45 R20 W/275/40 R20 W	225/60 R18 W	225/60 R18 W	245/45 R20 W/275/40 R20 W
Wheel size		7J x 18	7J x 18	8J x 20/9.5J x 20	7J x 18	7J x 18	8J x 20/9.5J x 20
Material		Light alloy	Light alloy	Light alloy	Light alloy	Light alloy	Light alloy

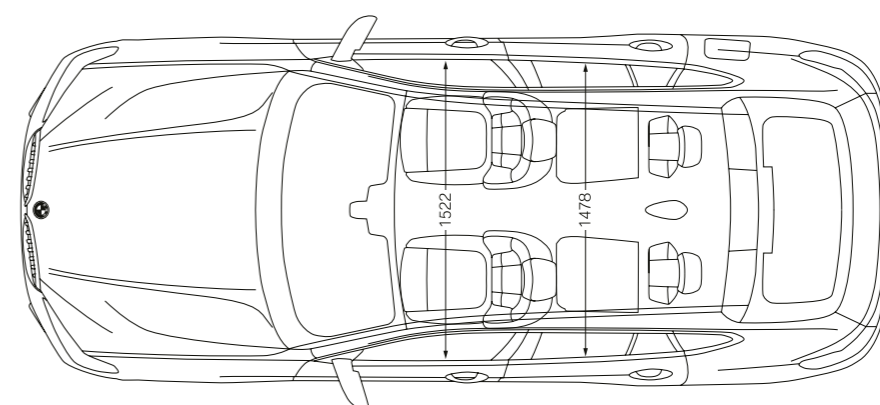
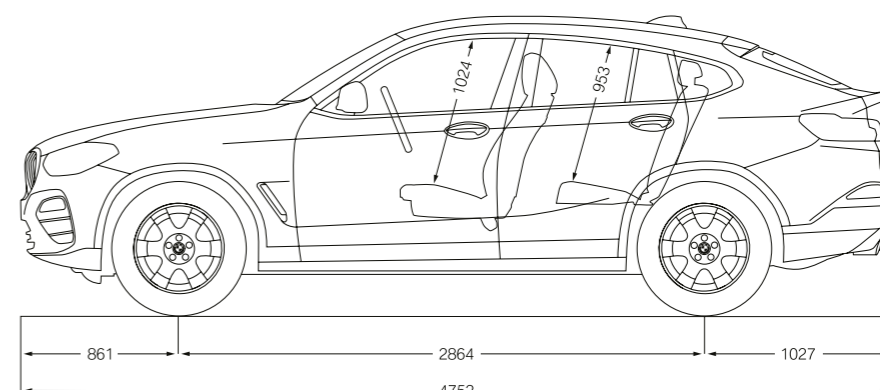
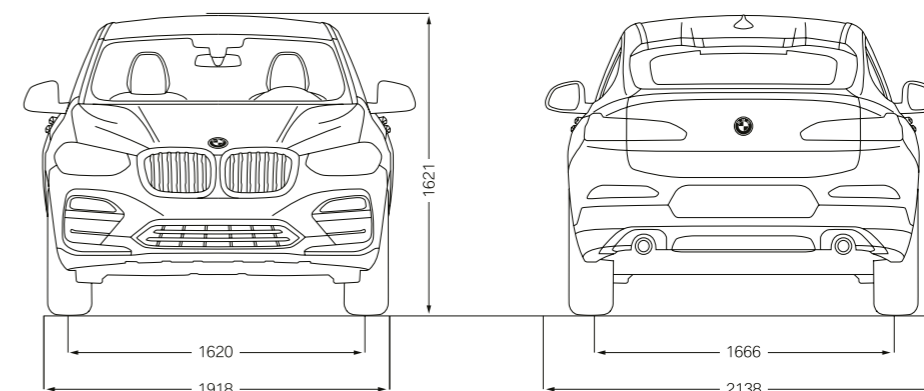

All dimensions in the technical drawings are given in millimetres.

Performance, fuel consumption and CO₂ emissions figures refer to vehicles with standard transmission.

¹ The EC unladen weight refers to a vehicle with standard equipment and does not include any optional extras. The unladen weight includes a 90% full tank and a driver weight of 75 kg. Optional equipment may affect the weight of the vehicle, the payload and the top speed if the selected equipment has an impact on the vehicle's aerodynamics.

² Only with factory-fitted trailer tow hitch, otherwise max. trailer load 2000 kg/2000 kg.

³ The actual total weight of the trailer must not exceed the maximum trailer load, taking into account the maximum tow bar download.

⁴ Electronically limited.

⁵ Performance data of petrol engines apply to vehicles using RON 98 fuel. Fuel consumption data apply to vehicles using reference fuels in accordance with EU Regulation 2007/715. Unleaded RON 91 and higher with a maximum ethanol content of 10% (E10) may also be used. BMW recommends RON 95 super unleaded petrol.

⁶ The data for fuel consumption, CO₂ emissions and energy consumption are determined in accordance with the measurements processes as defined by European Regulation (EU) 715/2007 in the applicable version. Data refer to a vehicle with base-level equipment in Germany, and the ranges account for differences according to the selected wheel and tyre size and the optional equipment. For these vehicles, values other than those specified here may apply for the assessment of taxes and other vehicle-related charges that are (also) based on CO₂ emissions. Version 06/05/2019

⁷ Provisional figures. Any missing figures were unavailable at the time of publication.

⁸ This engine version is not available in all countries. Please contact your local BMW partner for more information.

BMW X4 M40i.

BMW TwinPower Turbo inline 6-cylinder petrol engine, 21" BMW M light alloy wheels Double-spoke style 718 M with mixed tyres, Flamenco Red brilliant effect exterior colour, Sport seats for driver and front passenger in 'Verasca' Black leather with contrast stitching red, Aluminium Rhombicle interior trim finishers with Pearl Chrome accents, instrument panel in Sensatec black.

The models illustrated in this brochure show the equipment and configuration options (standard and optional) for vehicles produced by BMW AG for the German market. Alterations in standard and optional equipment and the configurations available for the different models, as described in this brochure, may occur after 03/18/2019, the date when this brochure went to press, or according to the specific requirements of other markets. Your local BMW Partner is available to provide further details. Subject to change in design and equipment.

© BMW AG, Munich, Germany. Not to be reproduced wholly or in part without prior written permission of BMW AG, Munich.

411 004 272 36 2 2019 CB. Printed in Germany 2019.